

TELTONIKA

GH4000 ADVANCED USER MANUAL

Contents

Introduction	4
Protection of copyright	4
Support	4
About this document	4
For your safety	5
EU declaration of conformity.....	6
Setting up Track Assistant 2.5	7
Minimal system requirements.....	7
Software setup process	7
Track Assistant 2.5	9
Header section functions.....	9
Menu.....	11
Contacts	11
SMS	12
Inbox	12
Sent	12
Send Message or Request.....	12
Device Configuration	13
General.....	13
Tracking and saving.....	14
Geofence.....	16
Alarm.....	20
Keyboard.....	40
GSM.....	44
Connections and data	51
Notifications.....	57
Security	60
Date and time	64
System.....	65

Firmware update	65
Monitoring	67
Configuration using SMS messages	69
Easy configuration	70
Advanced configuration.....	75
Configuration using terminal	76
FAQ	76

Introduction

GH4000 is hand held tracking device with built in functions and characteristics of a mobile phone. This device is intended for the surveillance and protection of people, cargo, objects. GPS/GLONASS receiver is able to identify current location coordinates and send them to operation center or a person. In case of emergency, the device can activate the alarm function. Also device can be used as real time navigation if computer has special software installed on it. Device is able to execute various tasks through GSM network and GPS/GLONASS system. Easy installation and operation, small size and user friendly design will help you to perform your desired tasks easier.

Protection of copyright

All rights protected. ©Teltonika 2017.

All rights are owned by the author. You may not copy, compile or transfer the present.

Information to third parties or distributes it without a prior written consent by UAB Teltonika.

Other products and company names mentioned in this Manual may be trademarks or names of products of such companies.

Support

In case you have problems with the use of the product beyond your possibilities to solve it, please contact your local seller or your UAB Teltonika manager.

Notice!

UAB Teltonika recommends reading Advanced User manual carefully. UAB Teltonika does not take any responsibility for problems that occur due to an inappropriate usage of a device, incorrect configuration or usage of software that was issued by a third party. UAB Teltonika reserves a right to modify the functionality of the device without any prior notice.

About this document

Advanced device functionality description is described in this document.

For your safety



Turn on and use device where it is safe to do this

Do not use device where mobile phone use is forbidden or where GSM network can be cause of the damage.



Road safety first

Do not cross local traffic laws. Always hold your hands on a steering wheel when using a device. Most important thing when you drive is safety.



Interference

All wireless devices are sensitive to interference, so use of device may affect the performance of another wireless device.



Limit the use of device in hospitals

Follow any restrictions. Turn off the device while being close to medical devices, where required.



Limit the use of device in vehicles

Follow any restrictions. Wireless devices can harm the use of electronic equipment in vehicles.



Be careful in gas stations

Do not use device or be careful using it near flammable materials.



Charging

Chargers, personal or laptops, device will be connected to, must comply with the requirements of DIN EN 60950-1:2003 standard.



Connection with computer

Computers, device will be connected to, must have USB slot.



Use only original batteries

The use of a different manufacturer or type batteries can cause an explosion.



Use batteries safely

Prevent batteries from moisture. Place them in a dry and cool place when storing. Prevent device from high temperatures. Do not try to charge battery straight from electrical socket.

Other



In order to prevent device from mechanical damage and failure it is advisable to transport it in the shock – resistant packaging. Connection quality depends on the environment in which device operates. If device stopped working properly only qualified specialist can help. In this case, it is recommended to contact your local seller or your UAB Teltonika manager.

Energy



Energy supply circuits, used for device connection, must have safeguards (automatic bipolar off), which will prevent from power leakage, short – circuiting or incorrect grounding. Switch must be installed in a readily accessible location. Power must be constant and the distance between the contacts must not to be less than 3 mm.



Safely remove device

Device can be disconnected from computer or charger by unplugging USB cable from computer or device.

EU declaration of conformity



CE 1304

This product complies with the requirements of the following Directives and carries the CE mark accordingly:
R&TTE Directive 1999/5/EC and RoHS Recast Directive 2011/65/EU.

Setting up Track Assistant 2.5

Software will help you to get the most of GH4000 functionality. It is main tool for device configuration and data reviewing. Software files, drivers and documentation can be found in UAB Teltonika internet address at: <http://www.teltonika.lt/downloads/>

Minimal system requirements

- Operating system (OS): MS Windows XP/Vista/7/8/8.1 (32&64 bit)
- Required hard disk space: 25,5 MB
- Minimal display resolution: 1024x768
- Windows Installer version: 3.0 or greater
- Microsoft .NET framework version: V2 SP2 or greater

Software setup process

1. Install software before connecting device to computer.

Notice!

Contact us or your local dealer if you are using different operating system than listed above. They will help you installing our software to your operating system.

2. Double click on the execution file. Follow wizard instructions to install Track Assistant software.

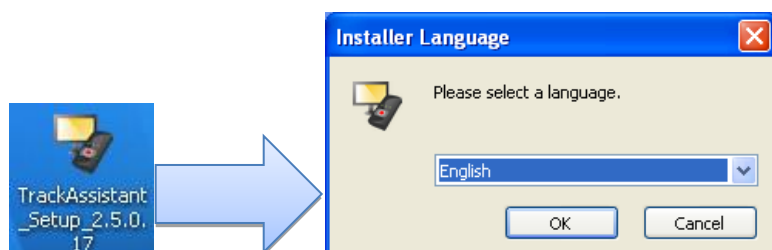

3. Select installer language.

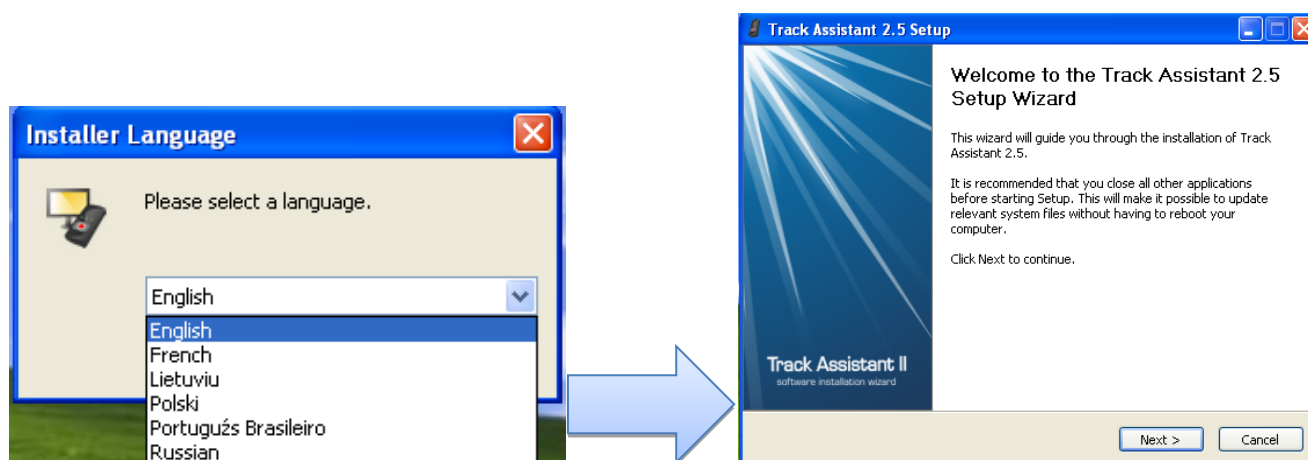

4. Read the license agreement and then press *I agree* button, to agree. If you disagree and don't want to install our software, press *Cancel*. Select components to install (if you already have older version of Track Assistant 2.5, you can uncheck drivers installation box).

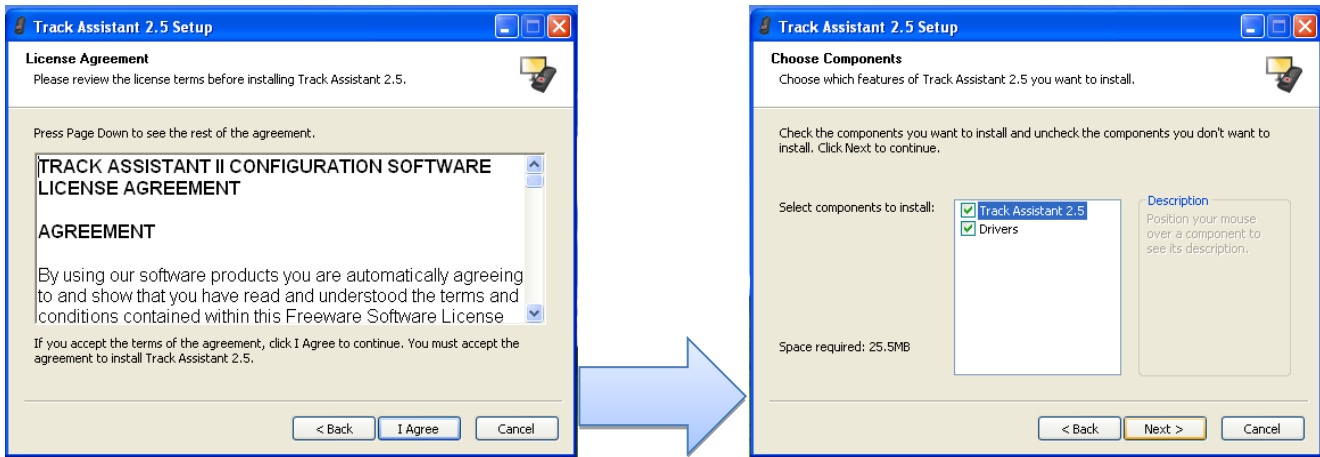

5. Choose users, for which Track Assistant will be installed. Choose program destination folder.

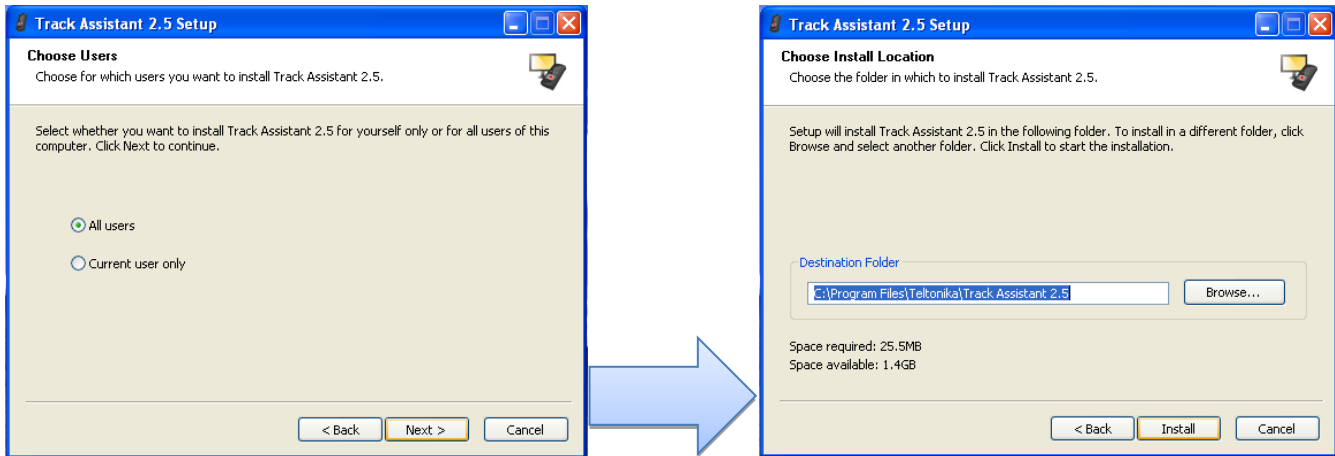

6. Please connect device and press *OK* if setup wizard will ask to connect device to computer. If you press *Cancel* device drivers will not be installed. Press *Continue anyway* if hardware installation window pops out.

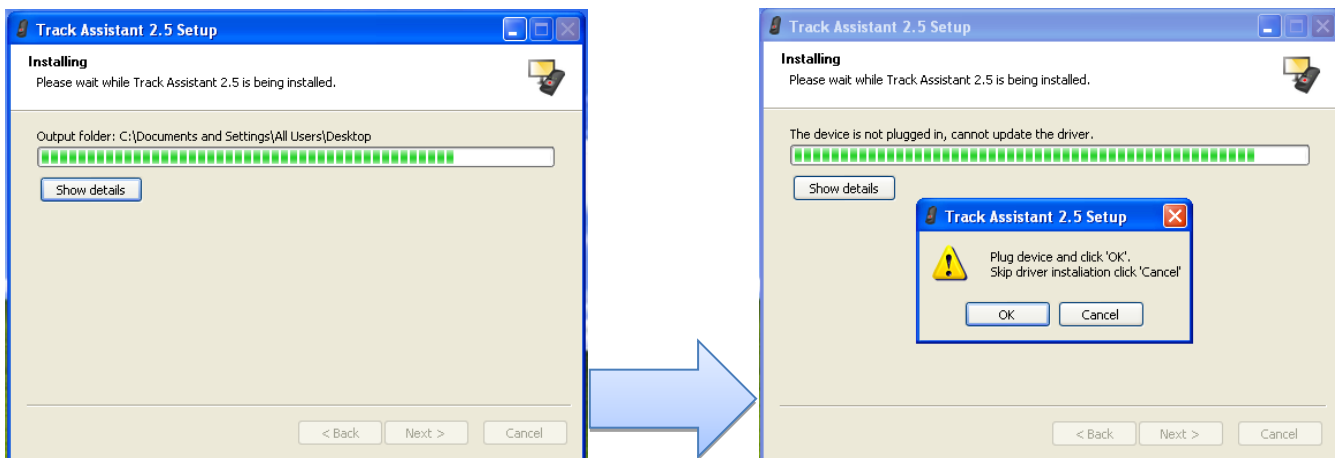

7. You have to restart computer, before using the software.

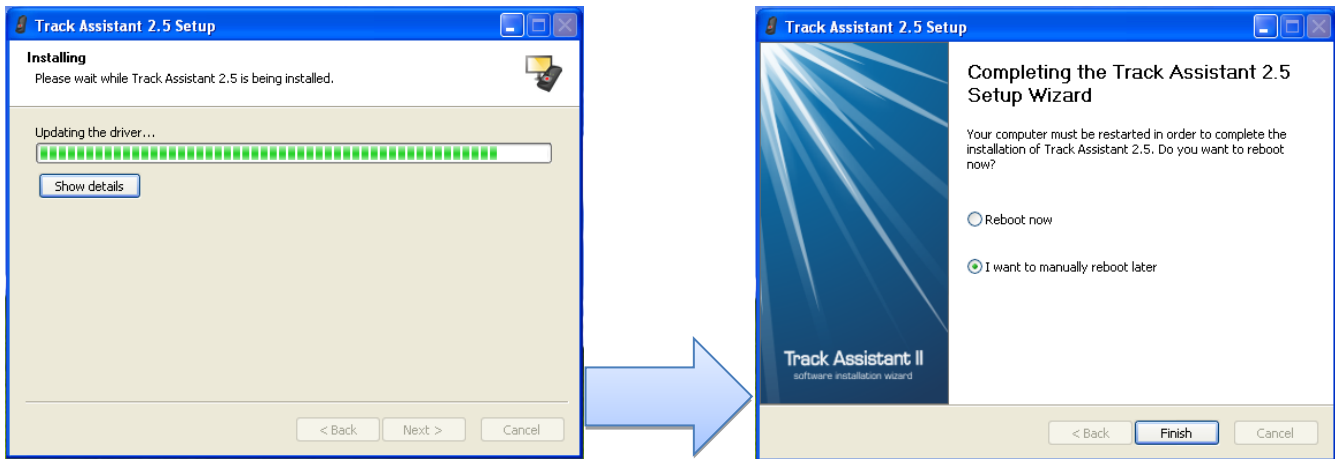

Track Assistant 2.5

Header section functions

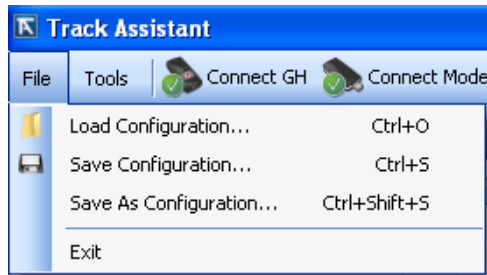

File option lets you load configuration file ____.afg, save configuration as a file, save configuration as a different file.



In section *Tools* → *Options* are located *General*, *GPS device*, *GSM modem* options.

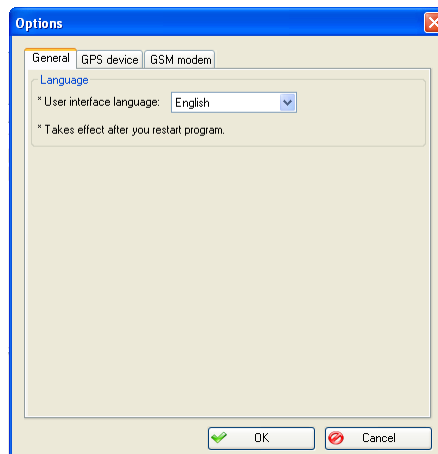

Track Assistant has selectable interface language:

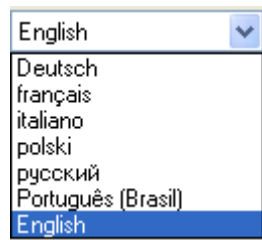

Under GPS device settings can be chosen GH4000 device port (how to find port number see *FAQ*) and GH4000 connection timeout. Other values are shown but they are hardcoded.

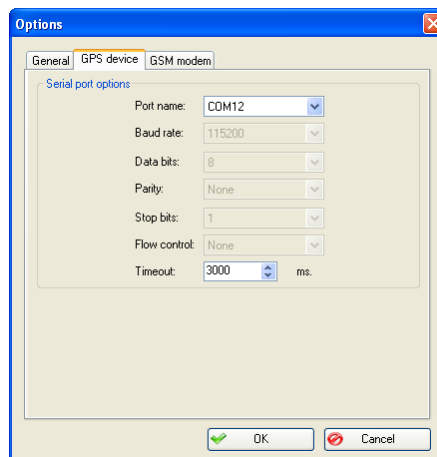

Under GSM modem settings can be chosen *GSM modem port, Baud rate, Data bits, Parity, Stop bits, Flow control* and connection *Timeout*.

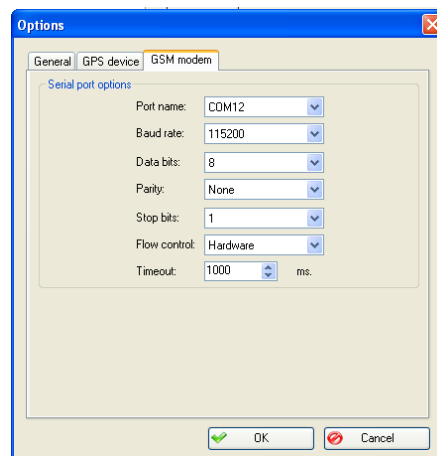

GH4000 configuration can be started by pressing *Connect GH* in Track Assistant 2.5.

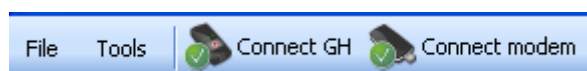

GSM modem can be connected to Track Assistant by pressing *Connect modem*. This function enables user to send SMS requests (see SMS) and configuration to your GH4000 and other devices.

Menu

Contacts

Track Assistant enables user to save contact list, which is used while configuring device. For example, there is chosen which person from contact list receives SMS or call in case of alarm or other event.

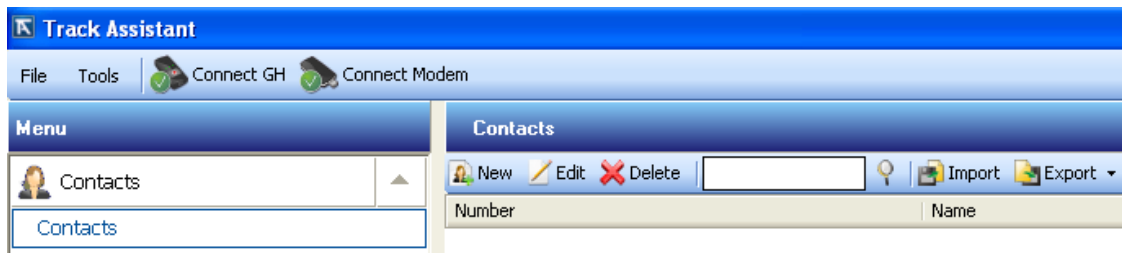

There are several functions under contacts menu. New contacts can be added: *Menu* → *Contacts* → *New*.

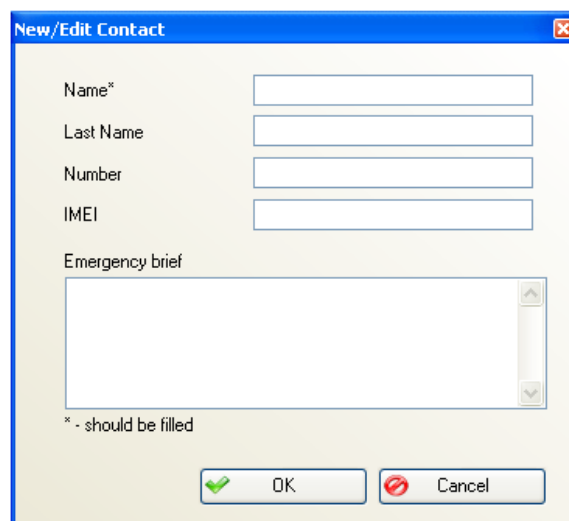
The "New/Edit Contact" dialog box has the following fields: "Name*" (required), "Last Name", "Number", and "IMEI", each with a text input field. Below these is a text area for "Emergency brief". At the bottom, there are "OK" and "Cancel" buttons. A note at the bottom left states "* - should be filled".

Following fields have to be filled up: *Name*, *Last Name*, *Number*, *IMEI*, *Emergency brief*. After pressing OK, Contact will be visible in Contacts list. Contacts info can be edited by pressing *Edit* or deleted by pressing *Delete*.



Desired contact can be searched in this field. By pressing magnifier icon search executes. Also there is a function to import/export contact list in CSV format. Example:

ContactId	ColumnNumber	ColumnName	ColumnLastName	EmergencyBriefs	ColumnIMEI
1	123	Contact	Contact_Last		321123

In customize menu there is ability to select columns to be visible in contacts list:

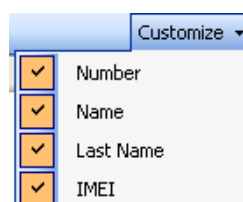

SMS

Inbox

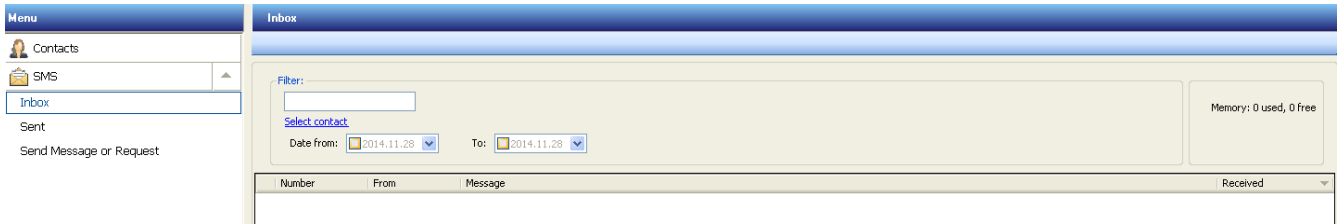

Messages, which were received using connected modem, will be shown in *Inbox* folder. Track Assistant has function to filter messages by contact and date.

Sent

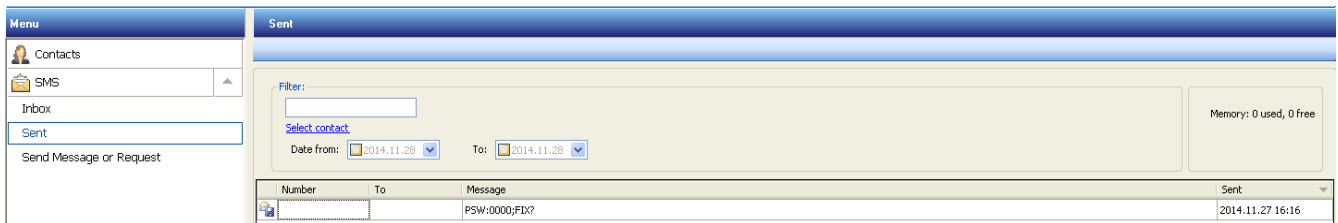

Messages, which were sent using modem connected to Track Assistant, will be shown in *Sent* folder. Track Assistant has function to filter messages by contact and date.

Send Message or Request

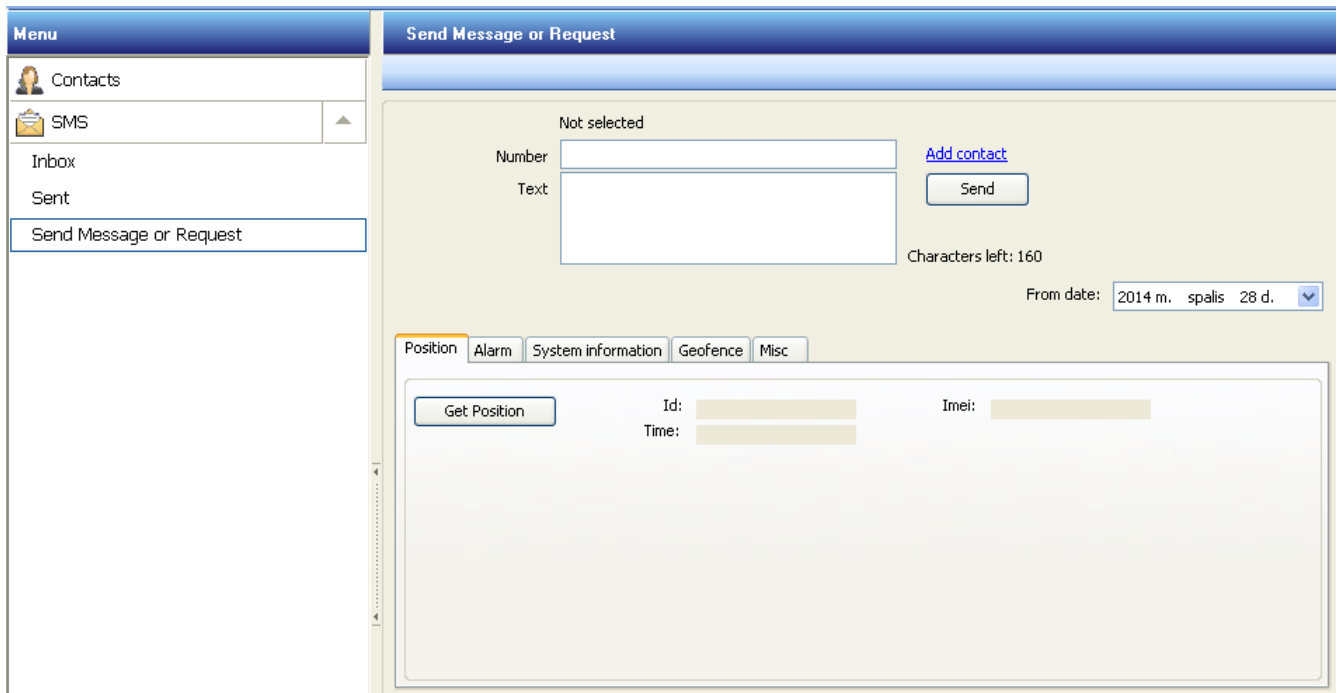

In this window, specific message can be sent to GH4000 or other mobile device. By pushing buttons various requests can be sent: FIX?, ALARM ON, ALARM OFF, INF?, RST, GEO?, TRACK?, SMSTRACK ON, SMSTRACK OFF. These requests are described in Firmware section.

Device Configuration

General

The screenshot displays the Track Assistant application window. The title bar reads "Track Assistant" and includes standard window controls. The menu bar contains "File", "Tools", "Disconnect GH", "Connect Modem", and "Help". A left-hand menu lists various configuration options: "Contacts", "SMS", "Device configuration" (selected), "General" (highlighted), "Tracking and Saving", "GeoFence", "Alarm", "Keyboard", "GSM", "Connections and Data", "Notifications", "Security", "Date and Time", "System", "Firmware", and "Monitoring".

The main area is titled "General" and features a "Refresh" button. Below it, the "Profiles" section shows a "Device name" field with the value "GH4000". The "Device info" section contains several fields:

IMEI	356173063001486	Device registered to:	
Firmware version	1.3.65		
Battery status	Charging		
GH status/COM port			
GPS module status	Disabled		
GSM module status	Enabled		
GSM signal level	100 %		
GSM operator	24602		

An "Apply" button with a green checkmark is located at the bottom right of the main area. The status bar at the bottom of the window reads: "Selected profile: Profile 1 | Connected device on COM3, IMEI: 356173063001486, VERSION: 1.3.65, DRIVER: Teltonika 0.0.5.1. | Modem disconnected ...".

General info tab shows such device information: IMEI, firmware version, battery status, GH status/COM port, GPS module status, GSM module status, GSM signal level, GSM operator code.

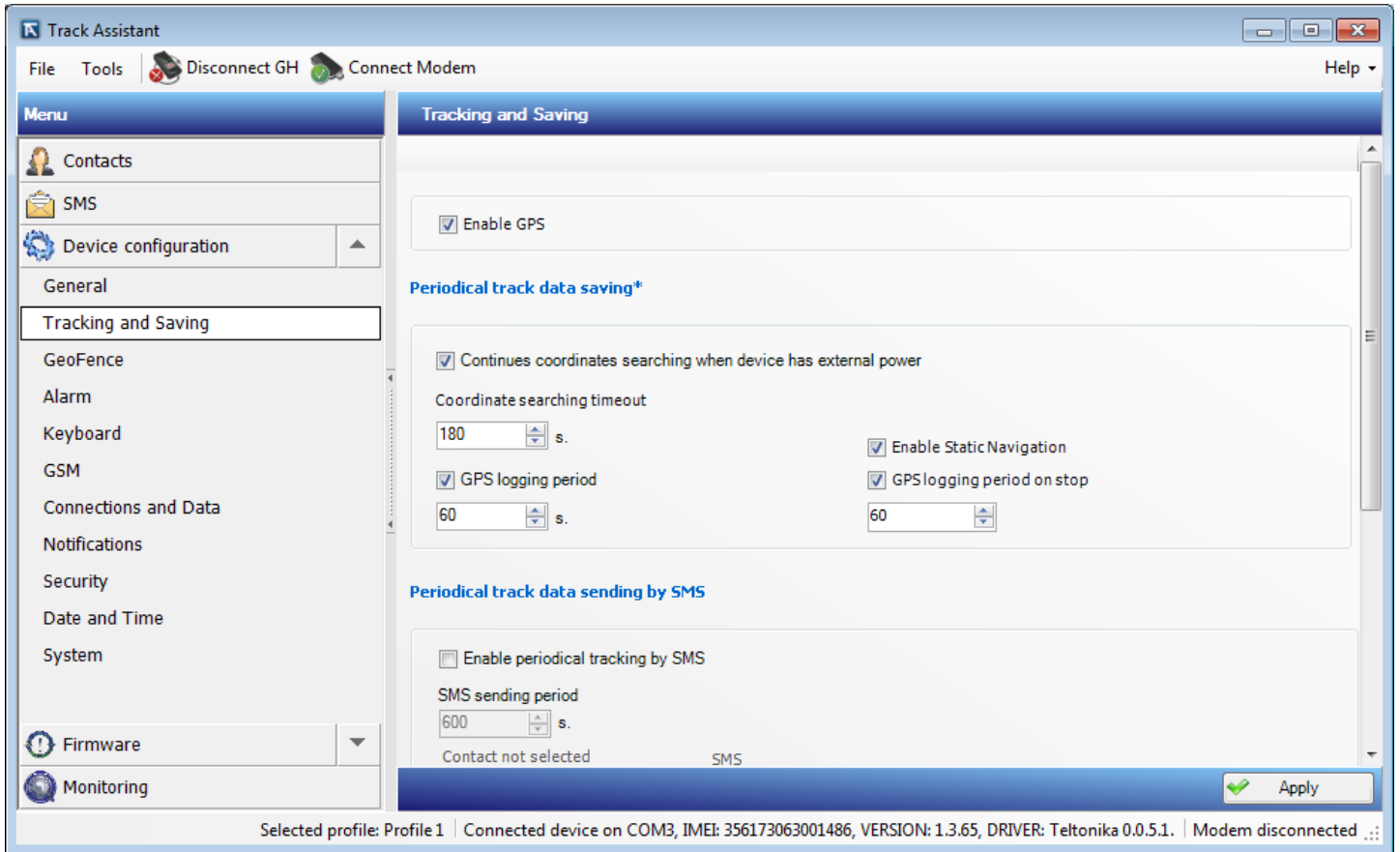

In this submenu GPS data logging settings can be controlled. In order to save changed configuration to device *Apply* button has to be pressed.

Parameter	Description	Default value
<i>Enable GPS</i>	Enable/Disable GPS/GNSS module.	Enabled
<i>Continues coordinates searching when device has external power</i>	If enabled (box ticked), GPS/GNSS module is not turned off while device is connected to computer via USB.	Enabled
<i>Coordinate searching timeout</i>	Time in seconds how long device will try to get coordinate. After this time expires device turns off GPS/GNSS module (stop looking for fix) even when device has not found stable coordinate.	180 s
<i>Enable Static Navigation</i>	If device has fix and it is not moving, then the device is not renewing GPS data and saving the last GPS data	Enabled
<i>GPS logging period on stop</i>	Enable/Disable periodical data saving. Time in seconds how often data will be saved to flash when device is idle.	60 s
<i>GPS logging period</i>	Enable/Disable periodical data saving. Time in seconds how often data will be saved to flash.	60 s

Periodical track data sending by SMS

Parameter	Description	Default value
<i>Enable periodical tracking by SMS</i>	Enable/Disable periodical tracking by SMS.	Disabled
<i>SMS sending period</i>	How often SMS will be sent.	600
<i>Contact</i>	Device will send SMS to this number.	-
<i>SMS</i>	Periodical SMS format ¹	Undefined SMS format! IMEI: <imei>; FIX! Id:<id> Imei:<imei> Time:<local_time> Fix:<fix_lat>,<fix_lon> Sat:<fix_satellites> Op:<operator> Cell:<cell_id> Sig_Lvl:<signal_level> Bat_Lvl:<bat_level>; SMSTRACK turned ON! Name:<id>; Time:<local_time>; SMSTRACK turned OFF! Name:<id>; Time:<local_time>; GEO! Name:<id>; Time:<local_time>; GeoZone:<geo>; INF! Name:<id>; Time:<local_time>; BatLvl:<bat_level>; OpId:<operator>; GSMSignLvl:<signal_level>; Prof:<current_file>; ExtPower:<power_ext>; IMEI:<imei>; *MN60;<fix_lat>;<fix_lon> ; ALARM! Name:<id>; Time:<local_time>; Lat<fix_lat> Lon<fix_lon>; Sat:<fix_satellites>; CellId<cell_id>; BatLvl:<bat_level>; Cause:<alarm_on>; ALARM Turned OFF! Name:<id>; Time:<local_time>; http://www.openstreetmap.org/?mlat=<fix_lat>&mlon=<fix_lon>#map=17/<fix_lat>/<fix_lon>; Cross in! ID:<id>; Time:<local_time>; GeoZone:<geo_name>;<geo_cross>; Lat:<fix_lat>; Lon:<fix_lon>; CellId:<cell_id>; Cross out! ID:<id>; Time:<local_time>; GeoZone:<geo_name>;<geo_cross>; Lat:<fix_lat>; Lon:<fix_lon>; CellId:<cell_id>; Call Terminated! Name:<id>; Time:<local_time>; Configuration changed! Name:<id>; Time:<local_time>; N<sms_id>; Charge BATTERY! Name:<id>; Time:<local_time>; Live:<up_time>; BatLvl:<bat_level>; Cross! ID:<id>; Time:<local_time>; GeoZone:<geo_name>;<geo_cross>; Lat:<fix_lat>; Lon:<fix_lon>; CellId:<cell_id>;

¹ Format can be selected from default templates or from your created template.

```
Battery full! Name:<id>; Time:<local_time>; Live:<up_time>;  
BatLvl:<bat_level>;
```

Filters

The new method „Filters“ saves periodical records only when NMEA data (Altitude, Speed and PDOP) doesn't exceed configured thresholds. Filters functionality works only when records saving mode is “When location available only”.

Parameter	Description	Default value
<i>Enable Altitude filter</i>	If enabled, filters out records in which altitude exceeds configured thresholds	Disabled
<i>Enable Speed filter</i>	If enabled, filters out records in which moving speed exceeds configured thresholds	Disabled
<i>Enable PDOP filter</i>	If enabled, filters out records in which PDOP value exceeds configured thresholds	Disabled

Filters

Enable Altitude filter Min: 0 (meters) Max: 10000 (meters)

Enable Speed filter Min: 0 (km/h) Max: 200 (km/h)

Enable PDOP filter Max: 10

Geofence

This function allows setting up active zones on a map. Device will inform about cutting the edge of the zone by sending SMS message. This is very handy and easy way to track object when it is important that object will not leave or enter configured territory. Also it is possible to set times when a zone will be active.

Configuration

Geofence function can be configured in Track Assistant software: *Device configuration* → *Geofence tab*.

Field	Description
<i>New zone</i>	Creating new Geozones.

<i>Geofence zones table</i>	All created Geozones are written here. SMS format can be changed here. Geozones can be activated/deactivated or deleted.
<i>Notify numbers</i>	Numbers to which device will send SMS message (max. 2 numbers) are entered here.
<i>Time scheduling</i>	Time when device will response while cutting Geozones.
<i>Coordinates table</i>	Shows coordinates of Geozone.

Creating new Geozone:

1. Press *New zone* button. Map, where Geozone can be drawn shows up:

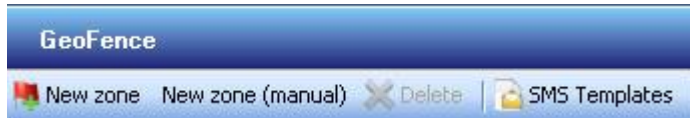

2. In the toolbar choose type of Geozone: Circle or Polygon:



Toolbar explanation:

Parameter	Description
<i>Circle</i>	Draws circle zone.
<i>Polygon</i>	Draws polygon zone.
<i>Move</i>	Navigation in a map.
<i>Done</i>	Confirm when zone drawing is finished.
<i>Cancel</i>	Cancel zone drawing.
<i>Map</i>	Choose what map You want to use.

3. Choose a site on a map and draw the zone.
4. Press *Done* (located in a toolbar) confirming the zone. Enter name of the zone, tick Enable if zone will be active.

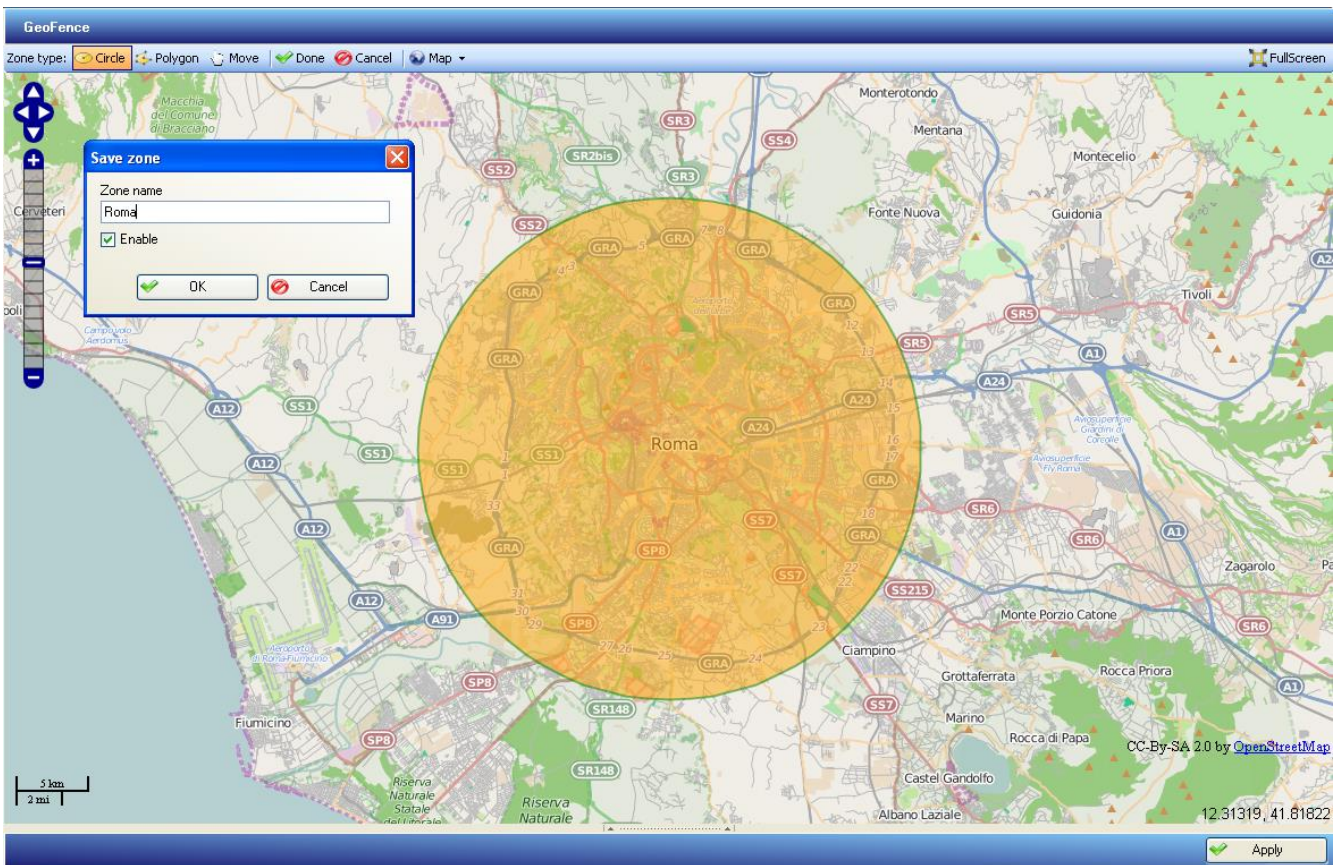

Notice!

- Polygon can consist of maximum 10 angles.
- Device can save maximum 50 zones in a memory.m
- Maximum thickness of a Geozone is about 100 meters. Pay attention to this because minimum space, where Geozone will be active is necessary.

There are two available SMS events – cross in and cross out. Device will send configured SMS crossing in and crossing out Geozone. SMS can be chosen from default or user created templates. User can see Geozone on a map, rename it or delete it by pressing on a Geozone with right mouse click. Weekdays and Geozone active time can be configured in time scheduling window.

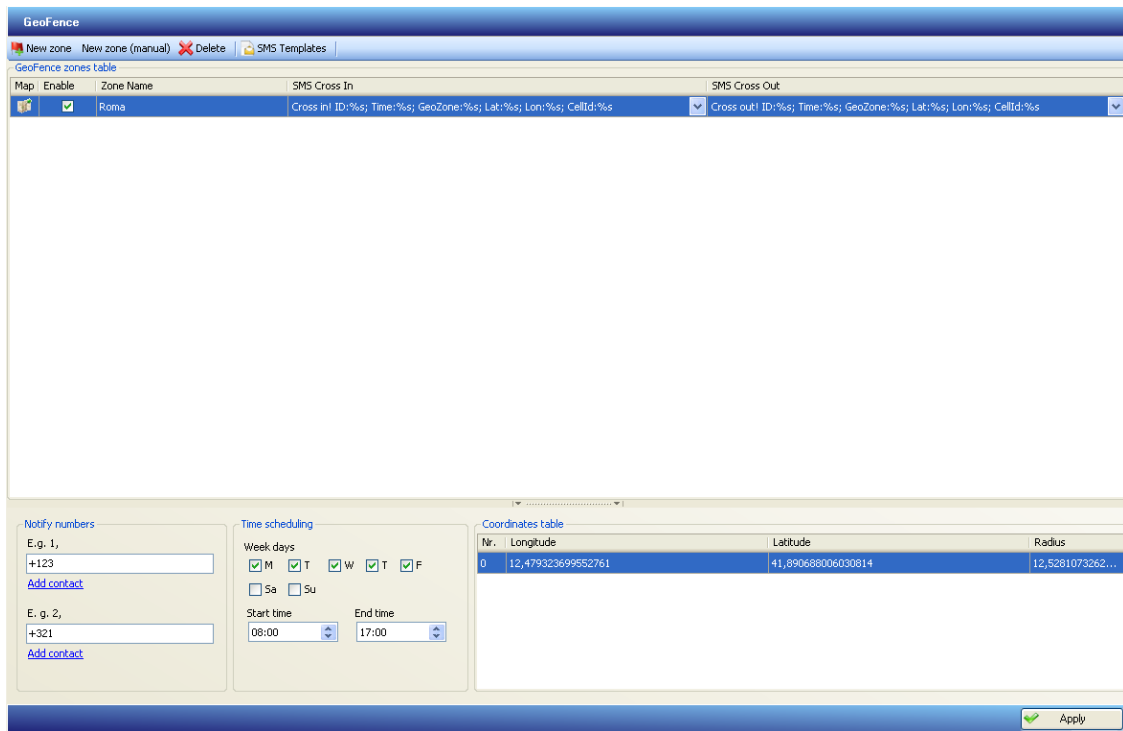

Operation

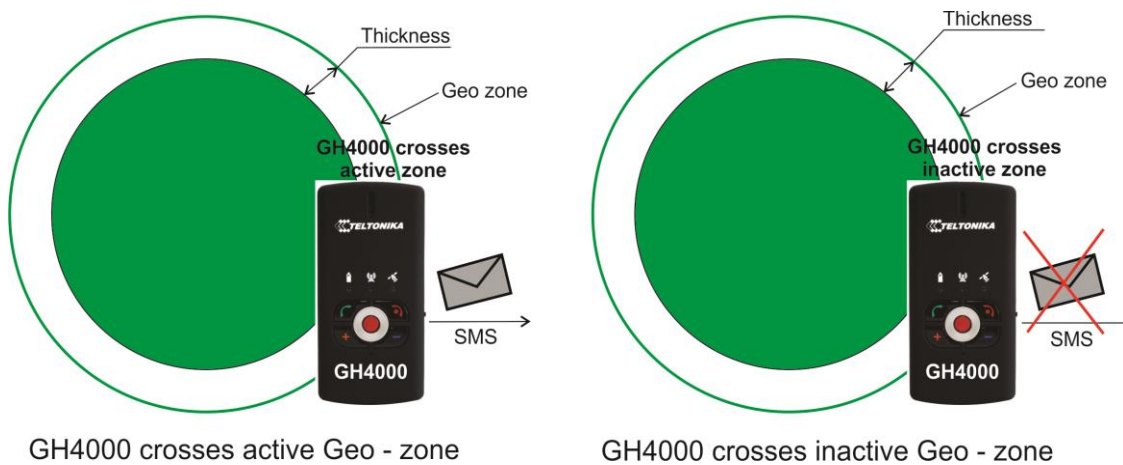

Examples:

1. If coordinate logging period is short device will inform immediately after crossing the zone.
2. If device coordinate logging period is pretty long, but device manages to record a coordinate while being in a zone, device will send SMS message a little later.
3. If coordinate logging period is long enough it is possible that device will cross in the zone and cross out not even noticed. In this situation GH4000 will not inform about crossing the zone.

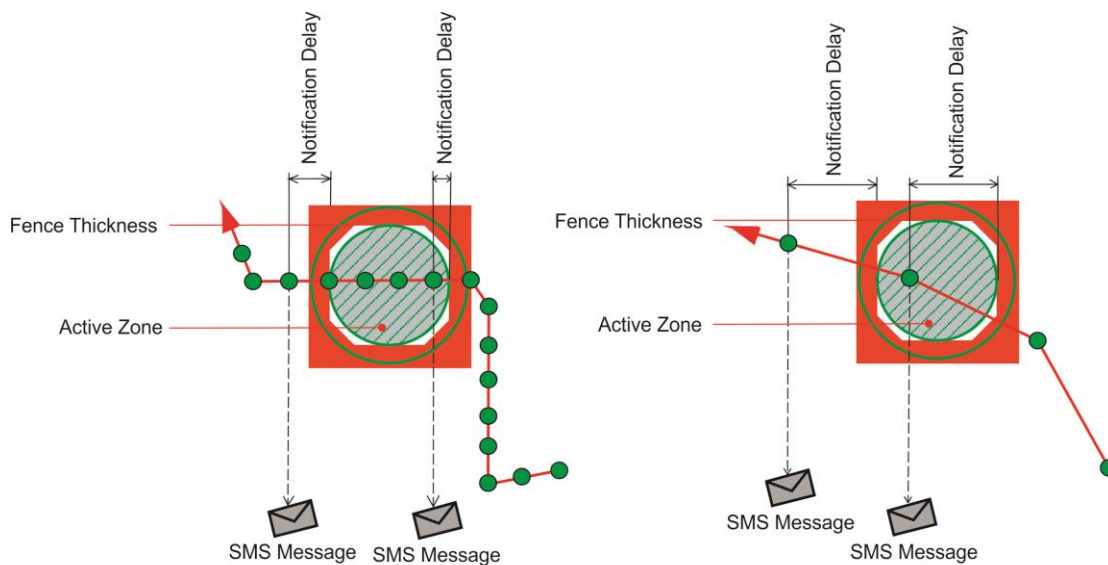

- no. 1.** Coordinate logging period is short. **no. 2.** Coordinate logging period is pretty long. SMS will be sent a little later.

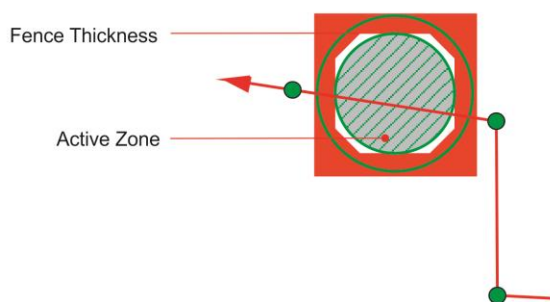

- no. 3.** Coordinate logging period is long. Zone crossing is not logged.

It is possible to send SMS request in order to find out in which Geozone device is. Information about that can be found in section SMS requests.

Alarm

This is one of the main features of the device. GH4000 works entirely different when Alarm mode is activated: battery is not saved anymore, device is always looking for new coordinates, tries to notify about current location by one of set method.

Configuration

Alarm mode can be activated/deactivated in 5 ways: by ALARM button, by SMS message, by activation by call, by parking function, by man – down function.

Activation/Deactivation

Type of activation	Description
<i>Keyboard button</i>	Button is configured in Track Assistant software (see Keyboard configuration). Function is activated right after pressing the button. By default alarm button is the red button in the center of the keyboard. 
<i>SMS request</i>	Alarm mode is activated/deactivated when this type of SMS request is sent to device: "psw<password> alarm on" – activate. "psw<password> alarm off" – deactivate. Exp.: psw0000 alarm on When there is no password: alarm on.
<i>Action On Call</i>	Function is activated or deactivated when device receives a call. Action on Call function must be set to Alarm on. (For detailed information look to Function activation on call).
<i>Parking</i>	Parking function is enabled. Alarm mode will be activated if device will leave parking zone. (For detailed information look to dynamic Geo - zone function).
<i>Man-down</i>	Man – down function is enabled. Alarm mode will be activated if device will change its position more than 68 degrees or logs fast movement. (For detailed information see Man – down function).

Alarm mode function configuration is located in Track Assistant software:

Device configuration → *Alarm* tab

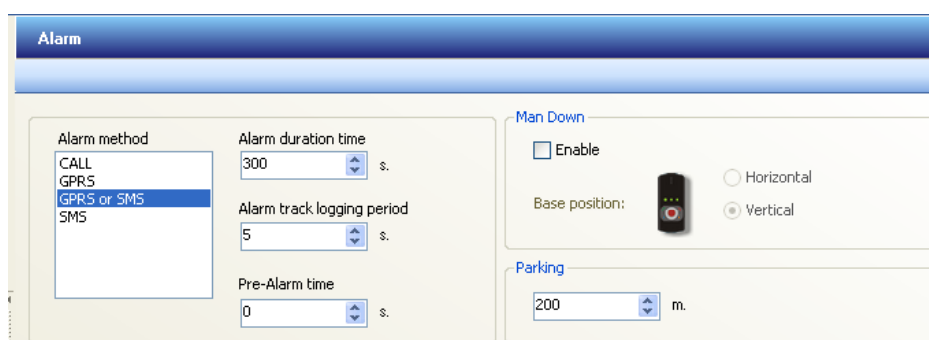

The screenshot displays the 'Alarm' configuration window. It is divided into several sections:

- Alarm method:** A list box containing 'CALL', 'GPRS', 'GPRS or SMS', and 'SMS'. 'GPRS or SMS' is currently selected.
- Alarm duration time:** A numeric input field set to '300' with the unit 's'.
- Alarm track logging period:** A numeric input field set to '5' with the unit 's'.
- Pre-Alarm time:** A numeric input field set to '0' with the unit 's'.
- Man Down:** Includes an 'Enable' checkbox (unchecked), a 'Base position' label, a small device icon, and two radio buttons: 'Horizontal' (selected) and 'Vertical'.
- Parking:** A numeric input field set to '200' with the unit 'm'.

This is main Alarm configuration section. Configurable parameters are explained in a table below:

Parameter	Description	
<i>Alarm method</i>	<i>CALL</i>	Device informs about alarm by cyclic call (see <i>Call method</i>).
	<i>GPRS</i>	Device sends saved data to server using GPRS (see <i>GPRS method</i>).
	<i>GPRS or SMS</i>	Device sends saved data to server using GPRS. If connection is not possible, device starts sending SMS messages. Configuration is same as described in GPRS or SMS method (see <i>GPRS method</i> , <i>SMS method</i>).
	<i>SMS</i>	Device informs about alarm by sending SMS messages (see <i>SMS method</i>).
<i>Alarm duration time</i>	Alarm duration time. Maximum time: 2592000s.	
<i>Alarm track logging period</i>	Coordinate saving period when alarm mode is activated. Maximum period: 65535s.	
<i>Pre-Alarm time</i>	PreAlarm takes place before Alarm. It is possible to stop Alarm activation before PreAlarm time runs out.	
<i>Man Down</i>	Configuration of Man-down function is here. Detailed explanation is described in Man-down section.	
<i>Parking</i>	Configuration of Parking function (dynamic Geo - zone) is here. Detailed explanation is described in Parking section.	

CALL (cyclic call) method

Contact list must be made in order to make cyclic call work when alarm is activated.

Cyclic call preferences are displayed below.

Send alarm by call*

No answer time	30 s.	1
Time for conversation	60 s.	2
Conversation overtime	60 s.	3
Time for alarm stop	60 s.	4

5

Call to:

[Add contact](#)
[Delete](#)

Phone number	Contact name
123456	Example1
456123	Example2

Up
[Down](#)

Parameter	Description
1. <i>No answer time</i>	Time for how long device will wait until contact will answer the call. Device will call to next number in a contact list after this time ends. Maximum waiting time: 180s.
2. <i>Time for conversation</i>	Time, which is given for conversation. Device will inform by short sound tone after this time ends. Maximum conversation time: 300s.
3. <i>Conversation overtime</i>	Time for how long conversation will last after <i>Time for conversation</i> ends. Device will terminate call and will call to next number in a contact list. Maximum overtime time: 300s.
4. <i>Time for alarm stop</i>	Time for how long device will wait until calling to next number in a contact list after call was answered by contact before. This command can be stopped by pressing (alarm off) button or by SMS (exp: terminate). Maximum waiting time: 300s.
5. <i>Send alarm to</i>	Provides contact list. Devices will call to these numbers one by one from to top to bottom. Maximum amount of numbers is 5.

GPRS (Global Packet Radio Service) method

Server information must be entered in order to send data using GPRS (nr.2 GPRS info picture below). These parameters can be configured:

Device configuration → *Connections and data* → *Server*.

The image shows a configuration interface for GPRS. It is divided into two main sections: 'GPRS' and 'Server*'.
 In the 'GPRS' section:
 - 'Enable GPRS' is checked.
 - 'Hold server connection alive' is unchecked.
 - 'GPRS send period' is checked and set to 300 seconds.
 - 'Send data on roaming' is unchecked.
 In the 'Server*' section:
 - 'Server address' is 212.47.99.61.
 - 'Server Port' is 17050.
 - 'Protocol' is TCP/IP.
 - 'noACK' is unchecked.
 - There is a link for 'Access point name (APN)' labeled 'Create new APN'.
 Blue boxes and arrows highlight specific fields: box 1 points to the 'GPRS send period' field, and box 2 points to the 'Server address', 'Server Port', and 'Protocol' fields.

Parameter	Description
1. GPRS send period	Every time this time is up device sends data to server if alarm mode is activated. Maximum period: 65535s.
2. Server	Server parameters. See <i>Server</i> .

What data will be sent to server can be set up:

Device configuration → *Connections and data* → *Periodical and alarm data*

SMS method

Alarm works only if contact list, which will receive alarm SMS, is set up.

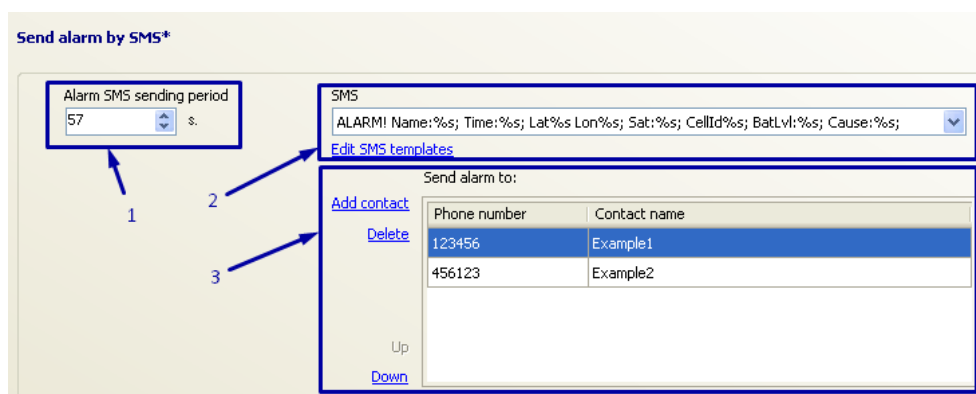

Configuration and detailed explanation of SMS method is described below. Device always sends the newest coordinate.

Parameter	Description
1. Alarm SMS sending period	Describes time period. After this time is up device sends SMS to numbers entered in <i>Send alarm to</i> list, when alarm mode is activated. Action will be repeated periodically. Minimal time period: 30s. Maximum time period: 2592000s.
2. SMS	Choose format of SMS message, which will be sent when alarm mode is activated.
3. Send alarm to	Contact list, which will receive SMS messages, one by one from top to bottom can be entered here. Maximum number of numbers is 5.

Operation

Alarm mode operation and activation method can be selected depending on user needs. Alarm function has higher priority than other functions. If functions are working simultaneously saving periodical and alarm data, alarm data saving will take priority to save alarm data first.

The use of PreAlarm is recommended when using alarm function. PreAlarm is made to prevent accidental alarm activation. Alarm activation can be canceled until PreAlarm time ends because PreAlarm is activated first. User can avoid false alarm using this function. Detailed operation of alarm mode is depicted in a picture “*Operation of alarm mode*”.

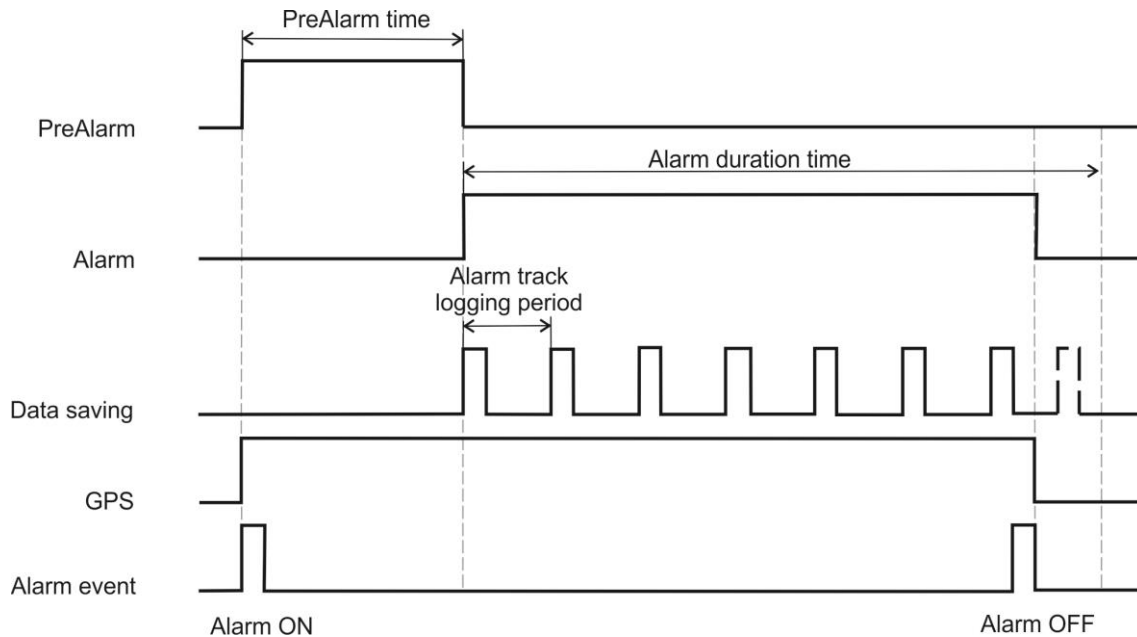

Operation of alarm mode

Alarm methods

Call

For example, device has two numbers in *Call to list*. GH4000 calls to first number in list, when alarm is activated. If call receiver answers the phone and call becomes active, *time for conversation* begins to count. When *time for conversation* reaches configured value, device beeps. After that, *conversation overtime* counting is started. After *conversation overtime time* runs out call is terminated. By call termination device starts counting *time for alarm stop*, then device calls to second number in *Call to list*.

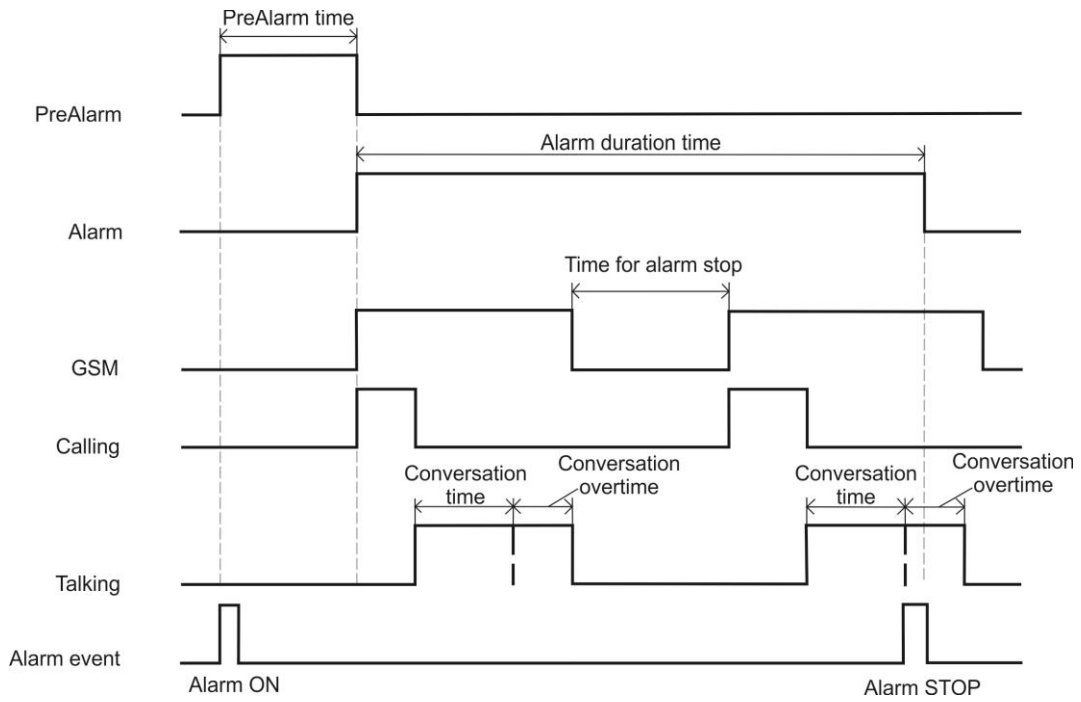

Call method

If first number in list does not answer the call, device waits *no answer time* and then terminates call. After that, device calls to second number in list.

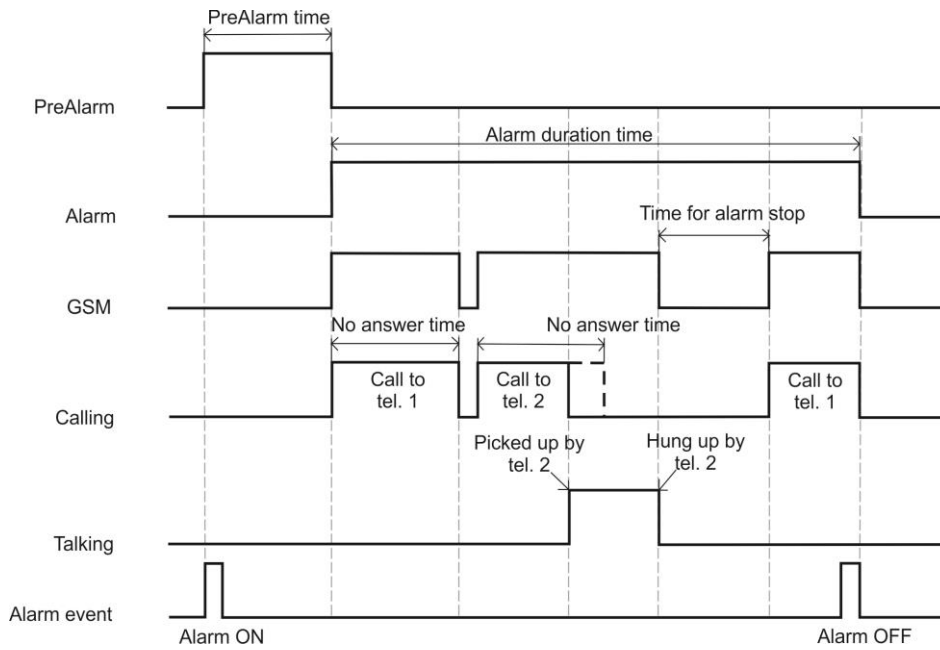

Call method – first number in list is not answering the call

If first number in list terminates incoming call, GH4000 calls to second number in list.

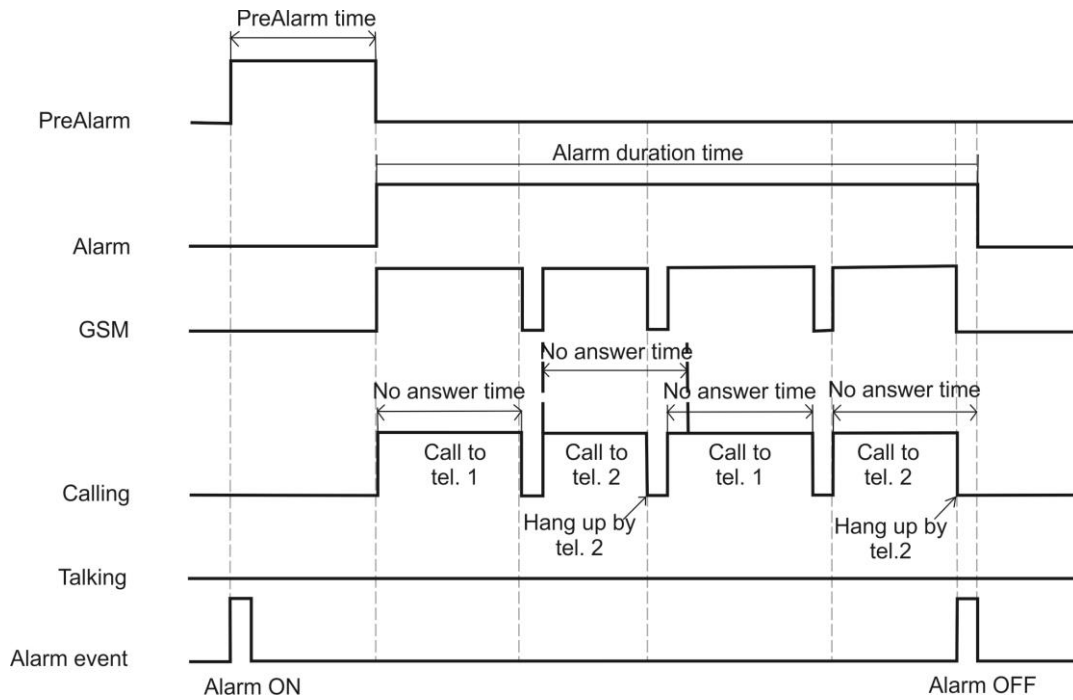

Call method – first number in list terminates incoming call

Device will start from beginning of list after trying to call to all numbers entered in *Call to* list. Device stops calling to contacts, but alarm mode is active after SMS command *terminate* is sent to device. GH4000 continues collecting alarm data. To deactivate alarm send *alarm off* SMS command. Device stops calling after alarm mode is deactivated.

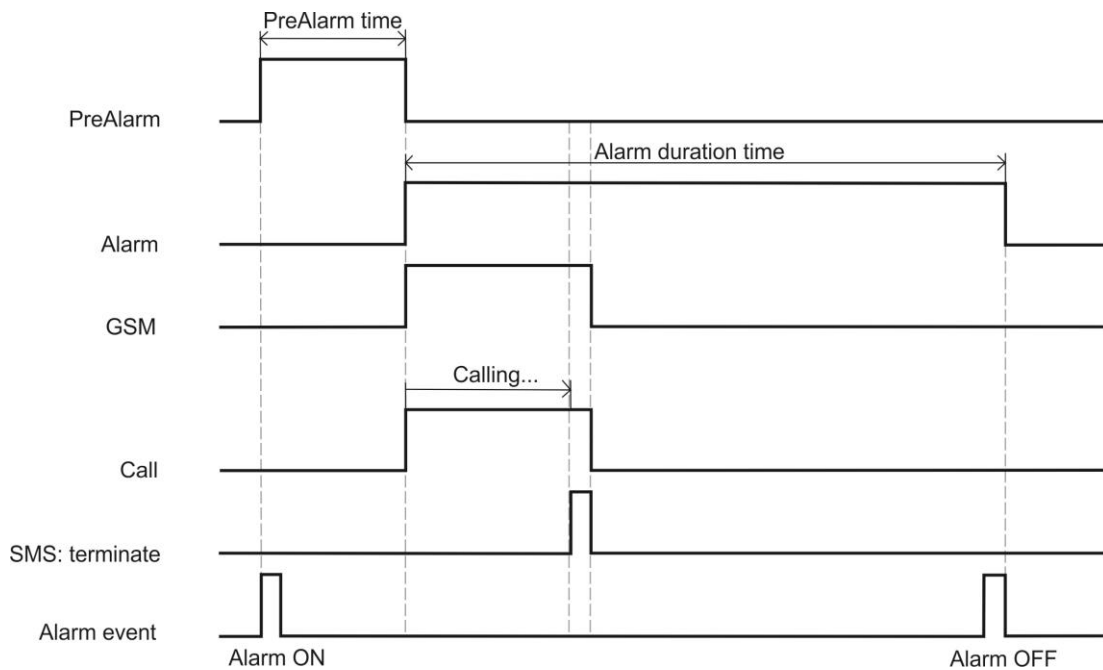

Call method – SMS terminate is sent to device

Device called to first number in *Call to* list. Call receiver answered and was informed about the accident. Information receiver sends SMS command *alarm off* to device in order to deactivate alarm. Device will stop calling to next numbers in *Call to* list. Alarm also can be deactivated by pressing the button with set up function *Alarm off*.

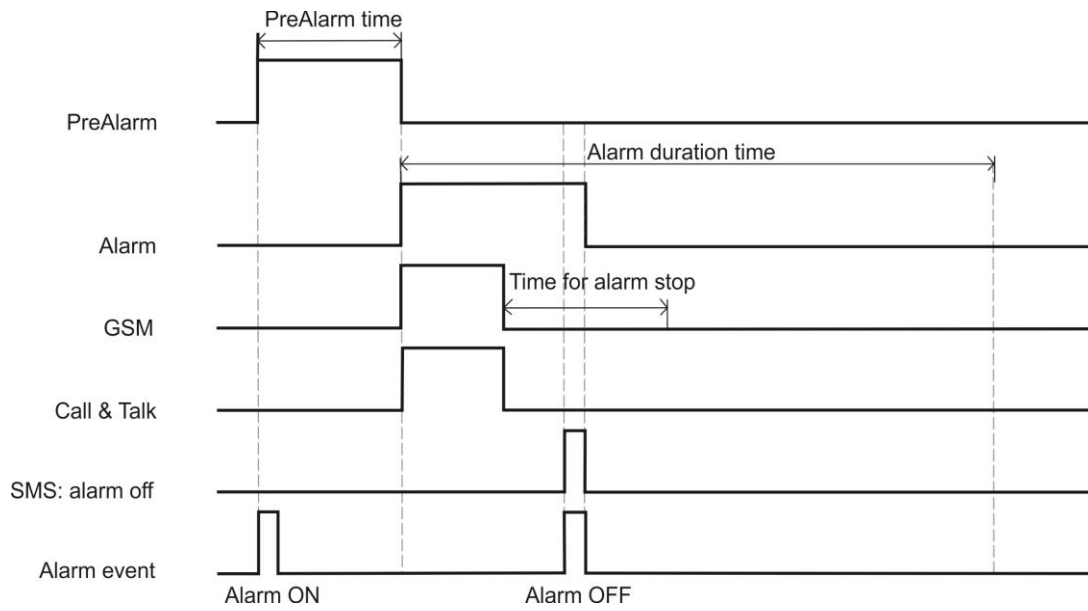

Call method – *alarm off* SMS is sent to device

GPRS

In GPRS method, when alarm mode is activated device will log alarm data at set alarm logging period and send to server at set sending period. Alarm sending period and periodical records sending periods are different. Data will be deleted from the device memory after successfully transferred to server.

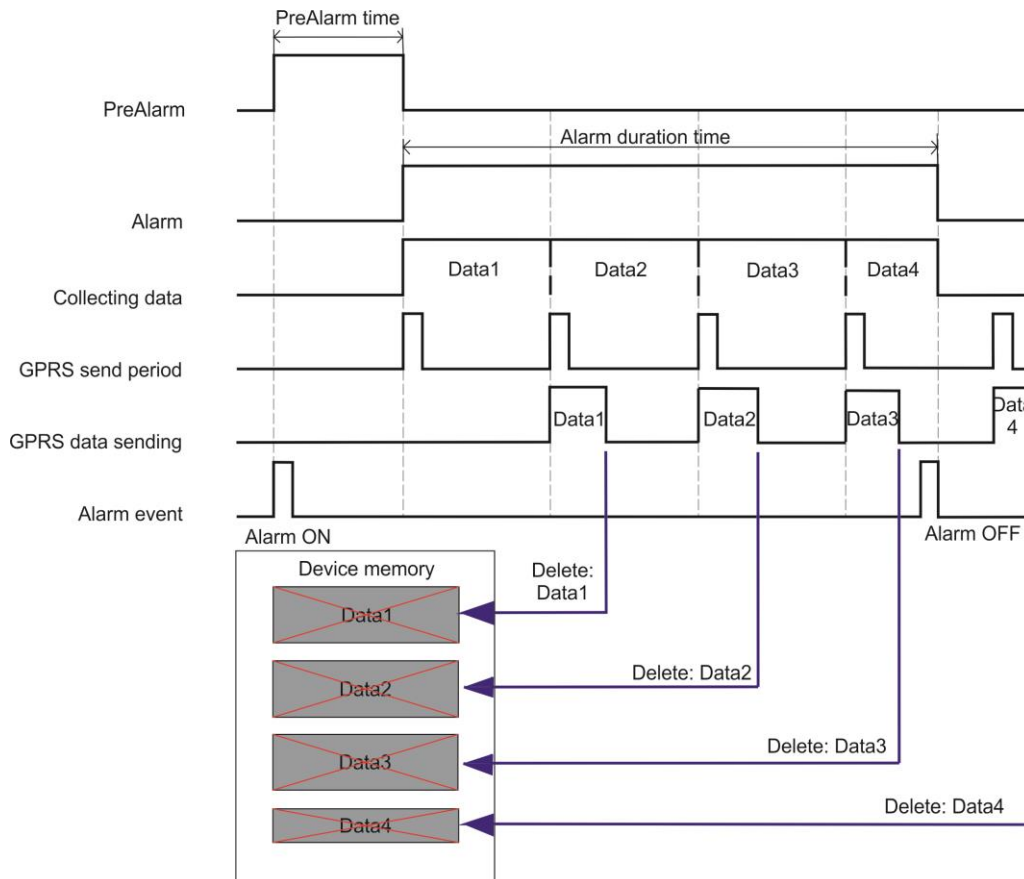

GPRS method

Notice!

Data Data4 will not be sent using GPRS if Alarm mode is deactivated. This data will be sent when Alarm duration time will be set to last longer. Data is not deleted if device fails to send it. Device tries to send this data when the next period starts. This operation is depicted in a picture “GPRS method – when device failed to send data”.

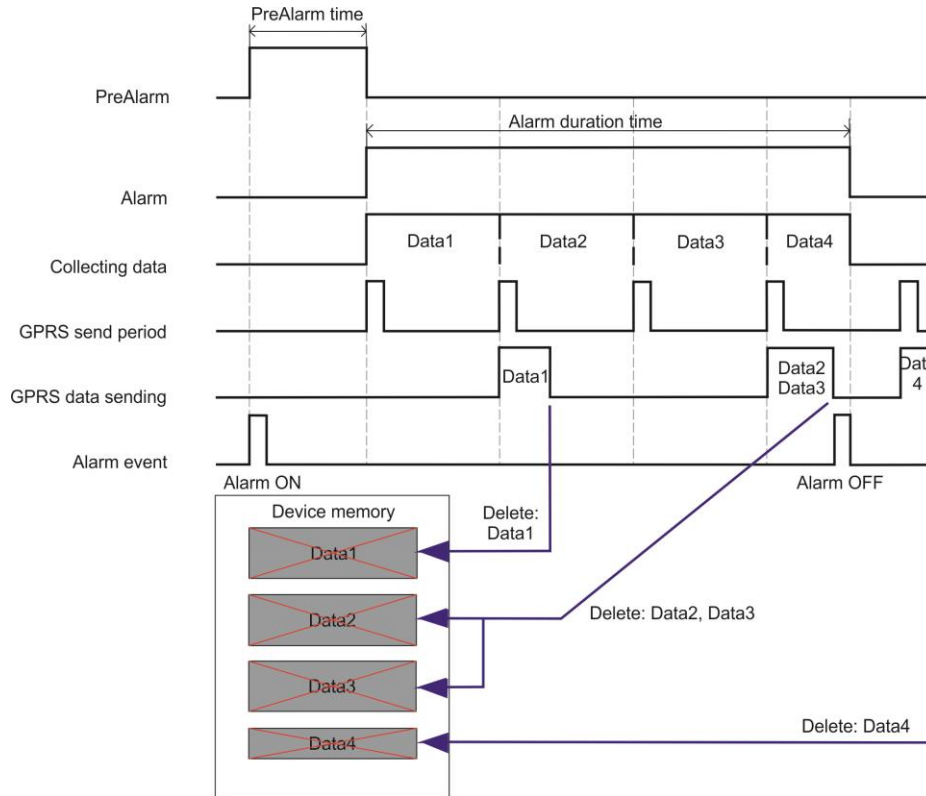

GPRS method – when device failed to send data

SMS

Alarm mode is activated. After *alarm SMS sending period* device will send SMS message to contacts entered in *send alarm to contact list*. If device fails to send SMS message it tries to send last unsent SMS message 5 times every next period. Device immediately sends last coordinate on a memory and waits for time to send a new one when opportunity to send data occurs. Alarm SMS format consists of: device name, time, latitude, longitude, visible satellites, cell ID, battery level, alarm cause. Alarm is indicated by number:

Number	Cause
1	Alarm function is activated by pressing a button.
2	Alarm function is activated by SMS message.
3	Alarm function is activated by function <i>Action on Call</i> .
5	Alarm function is activated by function <i>Man – Down</i> .
6	Alarm function is activated by function <i>Parking</i> .
7	Alarm function is extended after device reset.

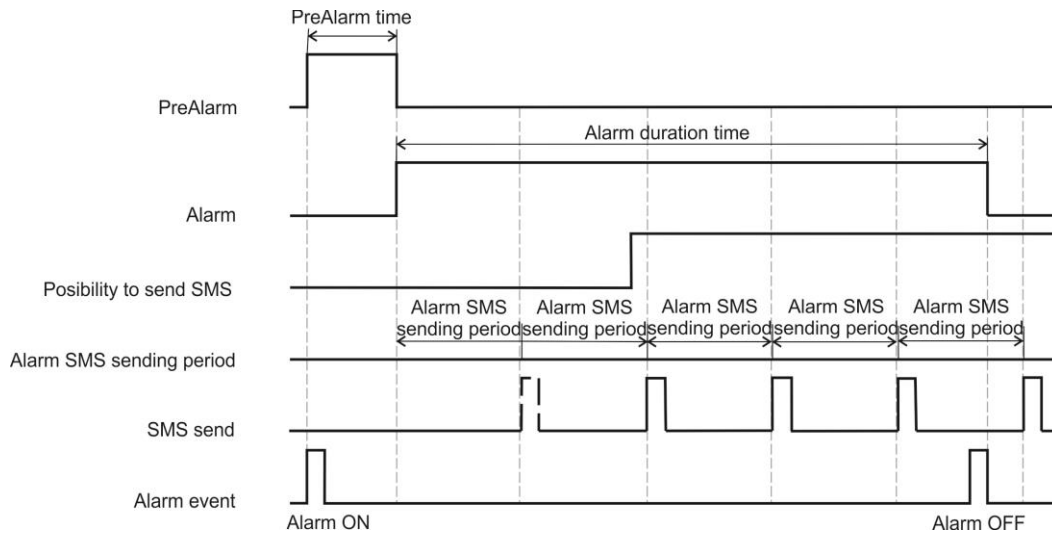

SMS method

Notice!

Parameter Max response time (see Device configuration and operation with SMS messages → SMS request) does not affect Alarm SMS method.

GPRS or SMS

In this mode device starts to send alarm data in GPRS method and can switch to SMS method if device fails to connect to server. SMS method is switched back to GPRS method when connection with server is possible. Operation of this combined method:

- Device sends data through GPRS.
- Connection with server is lost or not possible.
- Device starts to send SMS messages 90s after failure of GPRS method.
- Device tries to send data through GPRS on every set period. Device turns off SMS method if device successfully connects to server. SMS method can be turned on again if device fails to connect to server again.
- Device sends SMS one more time after SMS method is turned off.
- Device sends left Alarm data through GPRS after Alarm is deactivated and time for periodical data sending starts.

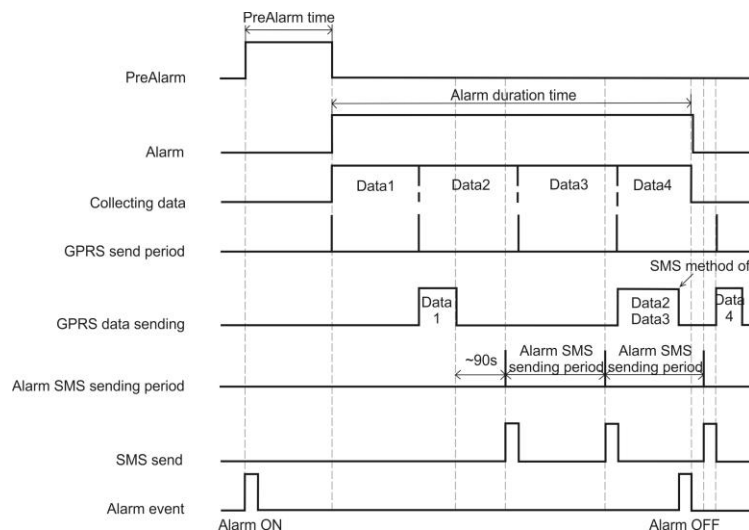

GPRS or SMS method – situation when device failed to send data using GPRS

Name	Description
<i>PreAlarm</i>	Warning signal.
<i>Alarm</i>	Alarm signal.
<i>GSM</i>	Connectivity with GSM operator (necessary for SMS sending, calling, GPRS).
<i>Calling</i>	Calling to chosen number.
<i>Talking</i>	Active call.
<i>Alarm event</i>	Alarm activation (Alarm ON) and deactivation (Alarm OFF).
<i>Call to tel.*</i>	Calling to number *.
<i>Call stopped by tel.*</i>	Call terminated by number *.
<i>SMS: terminate</i>	SMS message with command terminate is being sent.
<i>SMS: alarm off</i>	SMS message with command alarm off is being sent.
<i>SMS sent</i>	SMS message is sent.
<i>Collecting data</i>	Data is being collected and saved to memory.
<i>GPRS send period</i>	GPRS data send period.
<i>GPRS data sending</i>	Device sends data through GPRS.

Man-down function

This function activates monitoring of device position. If position is changed, GH4000 activates *PreAlarm*, if this function is activated and after *PreAlarm* time runs out *alarm* is activated. Device has to change its position by more than 68 degrees or fast position change must be monitored in order to activate *PreAlarm*. Consider the most stable position while using Man – Down function. It is important to keep device in its own special case. Case must be attached to belt or any place, which is stable while moving.

Man - down function can help when user can not activate alarm by button himself (example: loss of consciousness). Also in other situations, where object movement is important this function is very handy.

Configuration

Man-down function can be configured in Track Assistant software: *Device configuration* → *Alarm* and choose *Man Down section*. Detailed description is displayed in a table.

Parameter	Description
<i>Enable</i>	Enable/disable man-down function.
<i>Base position</i>	This is a position, which GH4000 will use as true (normal) position. All other positions will be treated as false ones and Alarm will be activated. There are 2 base positions to choose from: Horizontal – horizontal position. Attention! GH4000 must to lay on the side which has USB

connectors on it. 

Vertical – vertical position. Attention! GH4000 will use this position as its base only if it stands as displayed in the picture: 

Man – down function can be activated in two ways: in Track Assistant and with SMS request:

Parameter	Description
	Man-down function is enabled/disabled, when GH4000 receives this type of request message:
	" psw<password> EASY mandown on " – enables.
<i>SMS request</i>	" psw<password> EASY mandown off" – disables.
	Example: psw0000 EASY mandown on.
	If there is no password: EASY mandown on.

Operation

Man – Down function is using an integrated accelerometer. Tilt angle is calculated from this data:

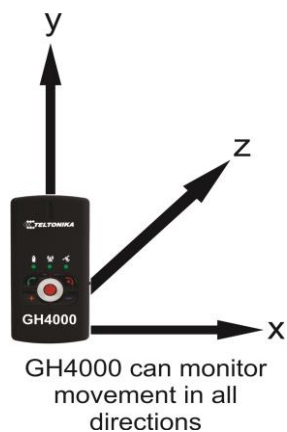

There are a lot of side effects (e. g. vibration) which can affect measurements of accelerometer. That's why GH4000 has an integrated filter, which helps to reduce the influence of such factors. Device reaction when Man – Down is enabled is displayed in pictures below:



True (base) position

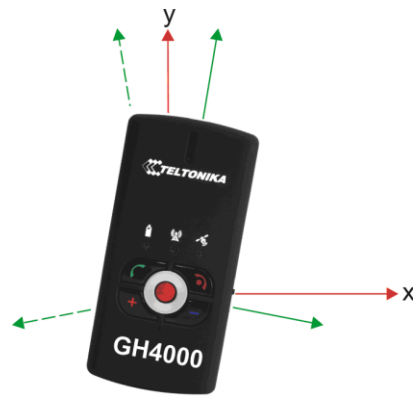

Position changed less than 68° degrees. *PreAlarm* is not activated.

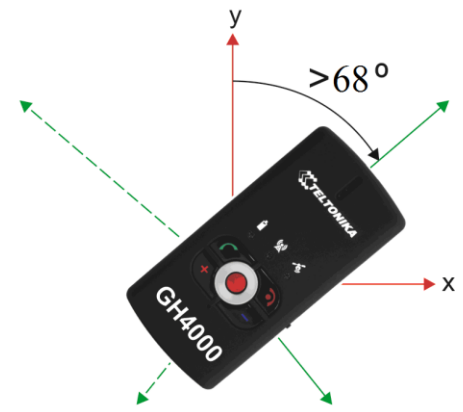

Position changed more than 68° degrees. *PreAlarm* is activated.

Man – down function is enabled and device position is changed more than 68 degrees *PreAlarm* is activated. If device goes back to its true (base) position until *PreAlarm* time runs out – alarm is not activated. Device continues monitoring its position.



Base position

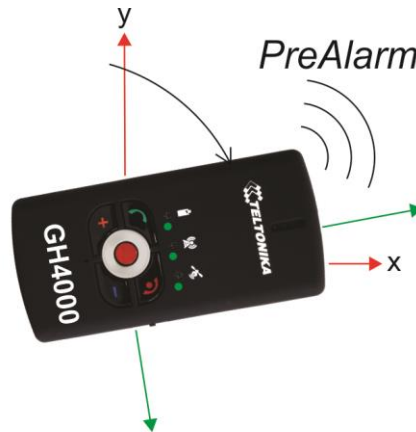

Position is changed. *PreAlarm* is activated.



Device goes back to base position. *Alarm* is not activated.

When *Man – down* function is enabled and device position is changed more than 68 degrees *PreAlarm* is activated. Device does not go back to its true (base) position until *PreAlarm* time runs out – alarm is activated.

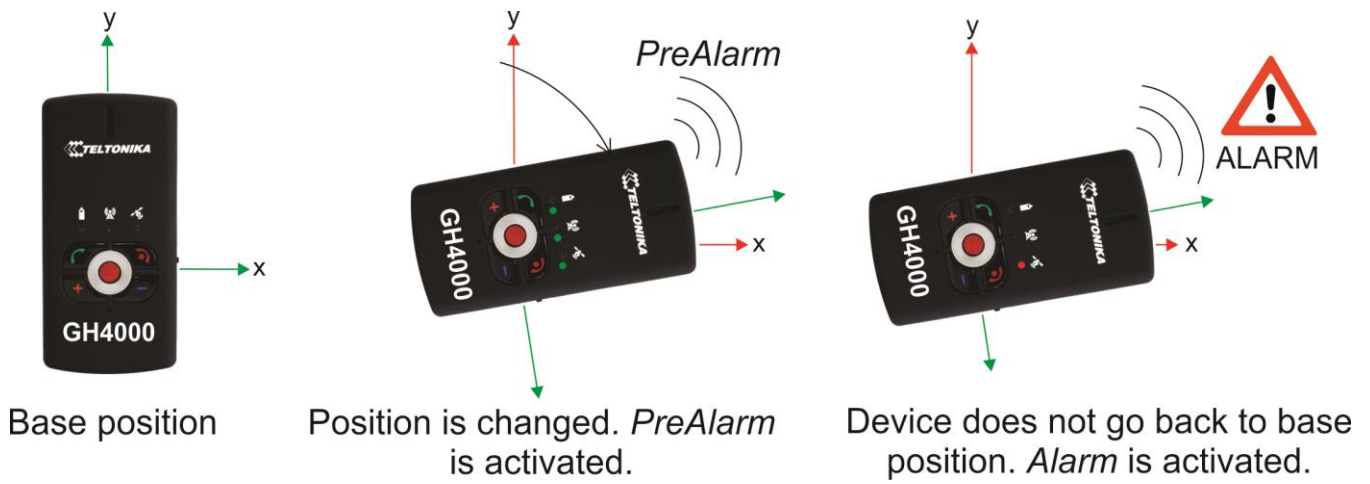

The use of Man – Down function

It is recommended to use *PreAlarm* in order to avoid false alarm activation when device position changed accidentally. Firstly device indicates change of the position with short tone. It means that Alarm will be activated soon. You can stop Alarm activation by bringing device back to its base position until *PreAlarm* time runs out. *PreAlarm* time should be 30 seconds or greater.

Do not carry device in a pocket while using Man – Down function in order to avoid false Alarm activation. Use only special case, which has to be attached to your belt:



Example how to correctly carry GH4000

Device position is changing about 30 degrees while carrying it in a pocket. Add 15 degrees of accelerometer error and result will be about 45 degrees. The same happens if the device is worn hanging on a neck. However device position is much more stable when carrying it in a special case.

Notice!

Error of accelerometer is about ~15 degrees. Please contact your sales manager if accelerometer is too sensitive.

Parking

This function allows activating monitoring of fixed location while using GH4000. Position monitoring is based on GPS coordinate or accelerometer (when it is not possible to get coordinate) measurements. There is no need to know where function will be activated, because device will automatically set up borders around itself (shape of a circle which has determined radius). Alarm is activated when parking zone is crossed or movement is recorded (accelerometer mode).

Configuration

Parking function can be configured in Track Assistant software: *Device configuration* → *ALARM* tab → *Parking* section.

Only distance parameter can be changed in this section. Parking zone will be crossed after device will move determined distance from current location. Maximum radius length is 3.4×10^{38} m.

Parking method can be activated/deactivated by: SMS message, *Action On Call* or by pressing keyboard button. Description of those methods is displayed in a table below:

Parameter	Description
SMS	<p>Parking function enabled/disabled when GH4000 receives this type of SMS message:</p> <p>"psw<password> park on r<distance>" - enable.</p> <p>"psw<password> park off" – disable.</p> <p>Parameter:</p> <p>psw<password> – password is entered.</p> <p>r<distance> - length of a radius. Minimum length of a radius is 200 meters. Default radius or radius used last time will be used if radius length is not entered.</p> <p>Exp.: psw0000 park on r300 - enables parking with 300m radius.</p> <p>psw0000 park on - enables/disables parking function.</p> <p>If there is no password: psw park on.</p>
Action On Call	<p>Function can be enabled/disabled, when GH4000 receives a call from <i>Action On Call</i> list which can activate/deactivate parking mode.</p>
Keyboard button	<p>Button is configured in Track Assistant which will activate/deactivate parking function (see Keyboard configuration for detailed information). Function will be activated right after button is pressed.</p>

Parking function can be enabled every time, except alarm mode is activated, there is an active call or an incoming call. Coordinate searching timeout is the same when using Parking function. This function can be configured:

Device configuration → *Tracking and Saving* tab → *Periodical track data saving* section.

Operation

There are several possible scenarios of this function:

1. Coordinate is found

Parking function is activated. GH4000 finds new coordinate and sets up parking zone. New coordinates are compared to the first coordinate. Distance is measured. Device logs crossing of a border and activates alarm if distance is bigger than the Parking distance. Device turns off its GPS module and stops searching for new coordinates (device battery is saved) when device is in a sleep mode.

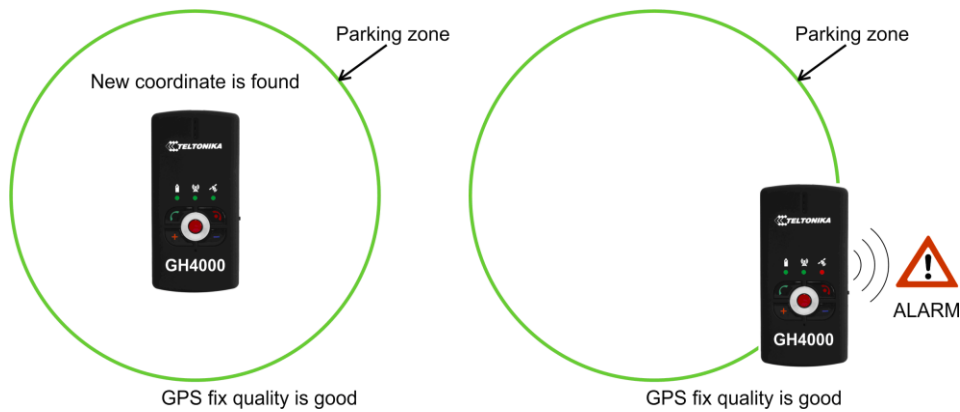

Couple scenarios, when device is able to get new coordinate, are displayed below.

a) There was no movement at first, coordinate is found, device has not left the zone:

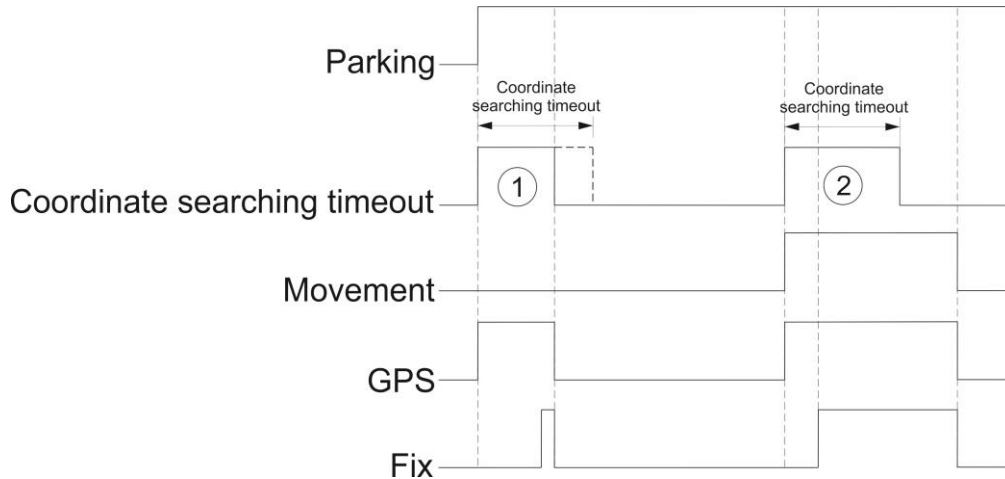

Operation of parking function when new coordinates are found and device does not leave the zone.

- 1 – Fix is found before *Coordinate searching timeout* time runs out.
- 2 – Movement of the device causes fix recording after *Coordinate searching timeout* time runs out.

b) There was a movement at first, coordinate is found, device has left the zone:

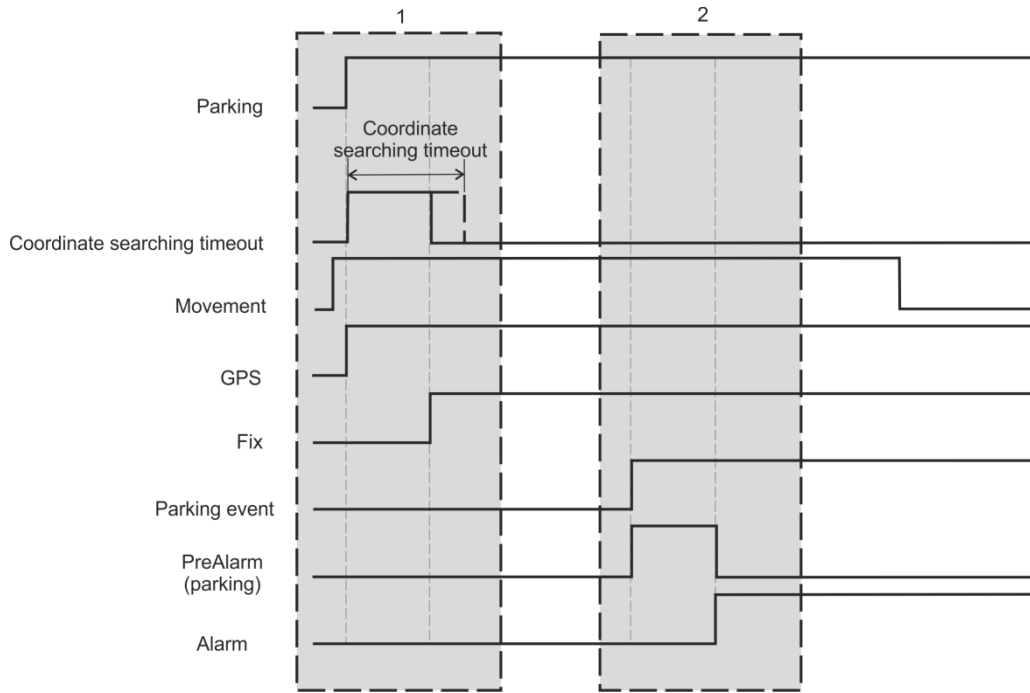

Operation of parking function, when new coordinates are found by the time device leaves parking zone and does not come back. There was movement at first.

1 – Parking function is activated. There is a movement. New coordinates are found. Device has not left parking zone, so there is no alarm. Device always tries to get new FIX, because there is a movement.

2 – Device left parking zone (parking event). *PreAlarm* is activated. Device has not come back to parking zone, so Alarm is activated.

c) There was a movement at first, coordinate is found, device has left the zone and came back, but after *PreAlarm* time:

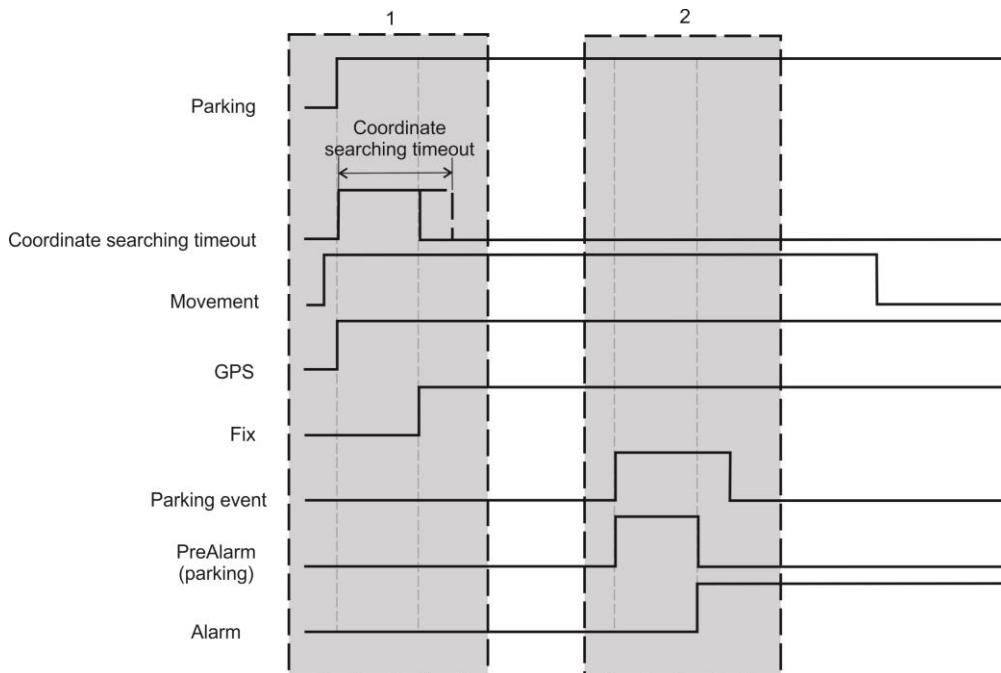

Operation of parking function, when new coordinates are found by the time device leaves parking zone and comes back after *PreAlarm* time. There was movement at first.

1 – Parking function is activated. There is a movement. New coordinates are found. Device has not left parking zone, so there is no alarm. Device always tries to get new FIX, because there is a movement.

2 – Device left parking zone (parking event). PreAlarm is activated. Device has come back to parking zone before PreAlarm time runs out, so Alarm is not activated.

2. Coordinate is not found

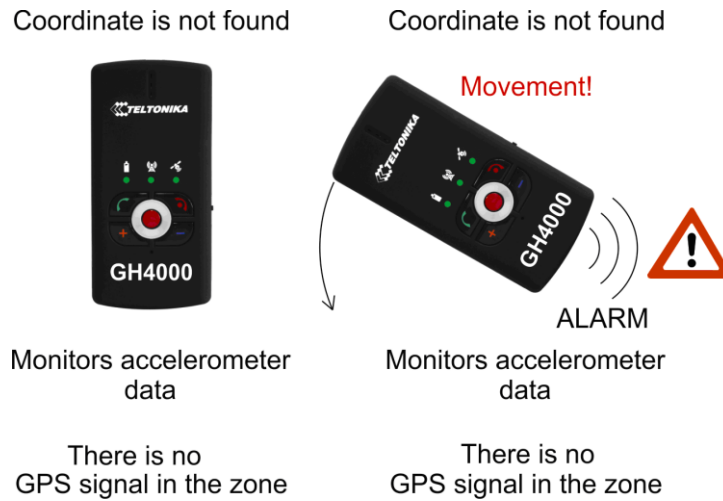

Parking function is activated. There is no movement. GH4000 does not find new coordinate. Device goes to movement (accelerometer) monitoring mode. PreAlarm is activated when movement is recorded. Alarm is activated after PreAlarm time runs out. Couple scenarios, when device is not able to get new coordinate, are displayed below.

a) There was no movement at first, coordinate is not found:

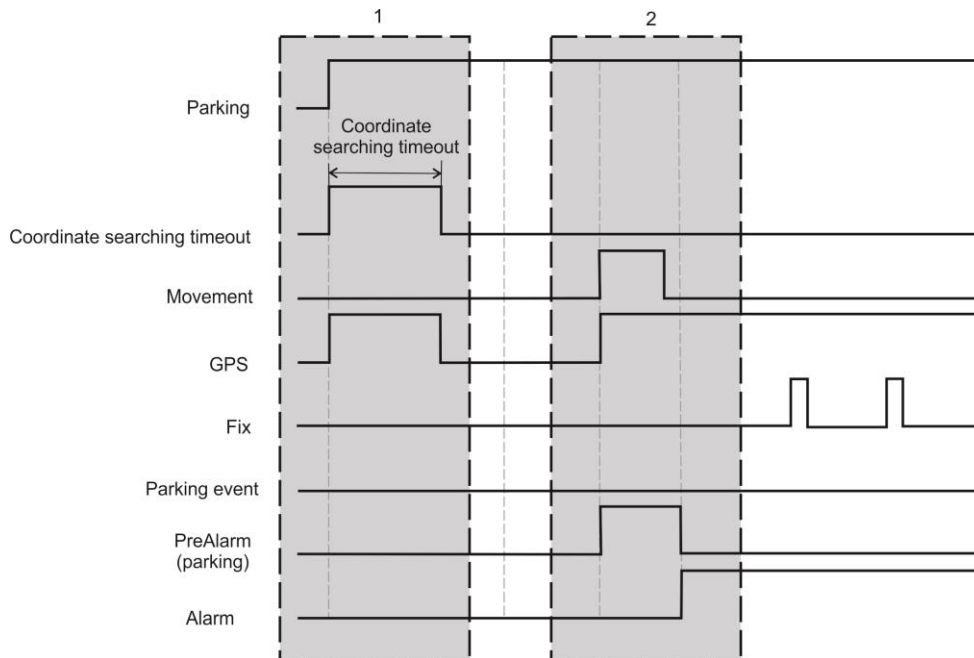

Operation of parking function, when new coordinates are not found. There was no movement at first.

1 – Parking function is activated. There is no movement, so there is no cause to activate an alarm. Device goes to sleep mode.

2 – Movement is recorded and PreAlarm is activated. Device tries to get new FIX. Alarm is activated after PreAlarm time runs out (there was a movement and location is not found).

b) There was a movement at first, coordinate is not found:

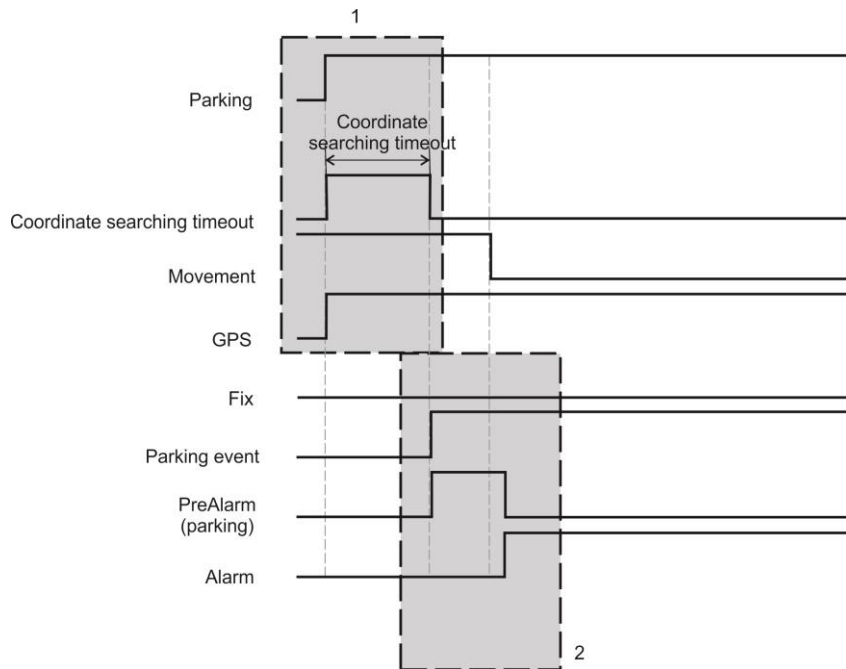

Operation of parking function, when new coordinates are not found. There was movement at first.

1 – Parking function is activated. There is a movement. New coordinates are not found during entire Coordinate searching timeout time.

2 – PreAlarm is activated after Coordinate searching timeout time runs out. Alarm is activated after PreAlarm time runs out (there was a movement and location is not found).

Notice!

Parking function is activated again after Alarm ends. Device sets up new Parking zone and tries to get new coordinates. Movement monitoring mode (Sleep mode) is activated.

Attention! When you are leaving parking zone, Parking function has to be switched off in order to avoid false Alarm activation. Parking function has its own PreAlarm signal. It means that Alarm has another PreAlarm time. So sequence will be like this PreAlarm (Parking) → PreAlarm (Alarm) → Alarm.

Detailed description:

Parameter	Description
Parking	Parking function activated/deactivated.

<i>Coordinate searching timeout</i>	Time, for how long device will try to get new coordinate. PreAlarm will be activated after this time runs out.
<i>Movement</i>	Movement of GH4000 (yes/no).
<i>GPS</i>	GPS module turned on/off.
<i>Fix</i>	New coordinate is found.
<i>Parking event</i>	Parking function event. Device left the zone or movement is recorded if new coordinate is not found.
<i>PreAlarm (parking)</i>	Parking function's PreAlarm.
<i>Alarm</i>	Alarm mode.

Keyboard

Device has 5 configurable buttons, reset button and lock switch. Keyboard helps user to control device. Every configurable button can perform users set functions, for example: call, send SMS, activate alarms and configure the device.



Configurable buttons are numbered in the picture. The reset button is shown with the arrow. It can be pressed only with something long and sharp like paper clip. Lock switch is located on the right side of device.

Keyboard configuration

Keyboard can be configured in Track Assistant software: *Device configuration* → *Keyboard* tab.



More configurable parameters are shown by clicking on *Show additional*:

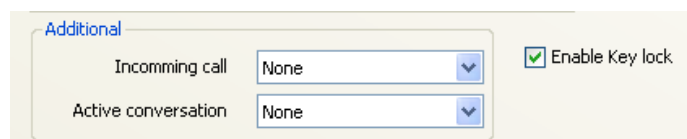

General tab description is listed in a table below:

Tab	Description
<i>Function</i>	Function that will be performed by clicking the button.
<i>Phone number</i>	If number is required to perform a function (call, SMS) it is entered in this tab. Desired SMS format is chosen there too.
<i>Additional</i>	Additional functions.
<i>Incoming call</i>	Function that will be performed by clicking the button on the moment the device is ringing.
<i>Active conversation</i>	Function which will be activated by clicking the button when device has active conversation.
<i>Enable Key lock</i>	If you enable this function button will not work when keyboard is locked. If you disable this function button will work even if keyboard is locked.

The same first functions are available with every button. Detailed description is listed in a table below:

First function	Description
<i>None</i>	No function.
<i>Undefined</i>	Function has not been chosen.
<i>Alarm on</i>	Activate alarm.
<i>Alarm off</i>	Deactivate alarm.
<i>SMS Track on</i>	Activate SMS track.
<i>SMS Track off</i>	Deactivate SMS track.
<i>SMS Track Switch</i>	Switch SMS track. If it was on, it is switched off. If it was off, it is switched on.
<i>Send data through GPRS</i>	All the data that has been saved in device memory is sent using GPRS. Sent data is deleted from device memory.
<i>NMEA On</i>	Activate NMEA.
<i>NMEA Off</i>	Deactivate NMEA.
<i>NMEA Switch</i>	Switch NMEA. If it was on, it is switched off. If it was off, it is switched on.
<i>Power Off</i>	Turn off device.
<i>Reset</i>	Reset device.
<i>Parking On</i>	Activate Parking (dynamic Geo - zone) function.

<i>Parking Off</i>	Deactivate Parking (dynamic Geo - zone) function.
<i>Parking Switch</i>	Switch Parking. If it was on, it is switched off. If it was off, it is switched on.
<i>Call</i>	Initiate a call to selected telephone number.
<i>SMS</i>	Send SMS. Number and SMS format is selected in Phone number tab.

Different additional functions can be activated during incoming call and active conversation. Detailed description listed in a table below:

Additional function	Description
Incoming call	
<i>Answer</i>	Answer incoming call. Start the conversation.
<i>Hang up</i>	Hang up incoming call
Active conversation	
<i>Hang up</i>	Hang up the conversation
<i>Volume up</i>	Volume up speakers
<i>Volume down</i>	Volume down speakers
<i>Mute on</i>	Mute the conversation
<i>Mute off</i>	Mute off the conversation

Operations

Function activation/deactivation

Function activation is controlled by pressing and holding button for 0.5 s. If activation is successful Green GSM and battery LED's light up and device makes a short tone. Desired function is activated right after minimal time (0,5 s) button is released. This is made to prevent accidental function activation. If button is not released and pressed longer than 3s, function is not activated. Green GSM and battery LED's light down and short tone informs that function is not activated. If function was activated accidentally hold the button for more than 3 s and function will not be activated.

Turn off button

Red phone (no. 2) button is used to turn off device. Device turn off is activated then this button is pressed and hold for 5s or longer. Short tone and green/red (both at the same time) battery LED will indicate device turning off.

Notice!

Time of the buttons activation is configurable via terminal or special commands (see configuration using terminal).

Locking the keyboard

Keyboard can be locked using a switch on a device right side. Two positions are possible:  - keyboard is locked and - keyboard is unlocked. Then keyboard is locked it is inoperable unless certain buttons have *Enable Key lock* function disabled.

Reset button

Device can be reset by pressing the reset button. In order to prevent accidentally pressing this button it can be reached only with something sharp and long (paper clip, needle). Reset button is right below 5 button keyboard.

Button ID

Every button on the device has its ID number, which can be sent to the server with other data as IO element. In this case user can identify which button activates GPRS data transfer.

Configuration

Identifier can be enabled: *Device configuration* → *Connections and Data* tab → *Periodical and alarm data*.

When identifier of pressed button ID is activated as alarm, button ID will be sent with alarm data. When identifier is activated as periodical parameter, it will be sent with periodically sent data.

Operation

Device attaches information about last pressed button when sends data to server:

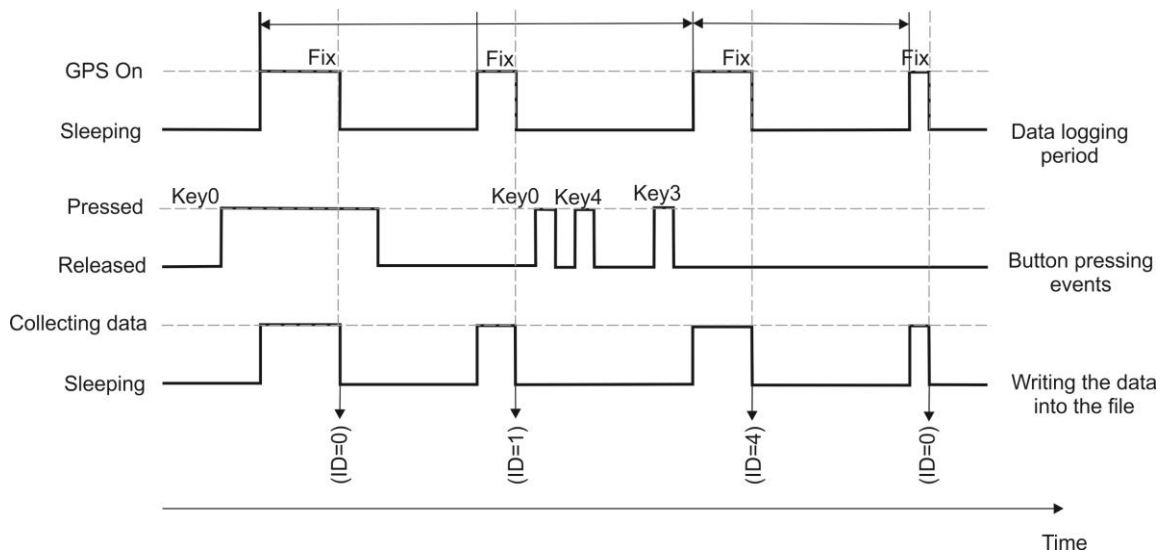

Pressed button ID events

Buttons and they ID numbers:

Button ID	Buttons on the keyboard
-	Button was not pressed
0	Key1
1	Key2
2	Key3

3 Key4

4 Key5

Notice!

Button event will be generated when button is pressed and released only.

GSM

Keyboard can be configured in Track Assistant software: *Device configuration* → *GSM*. To use GSM functions listed below you have to tick *Enable GSM*.

Silent call function

This function allows person to connect to GH4000 using voice call on the quit. There is no indication when *Silent call* function is active, so neither people around, nor device holder can notice it. In this case GH4000 can be used as a spy device.

Configuration

Use Track Assistant software in order to configure this function:

1. Device configuration → GSM;
2. Tick Enable silent call function.

Spy call function can be activated by using *SMS request* or using *Action On Call* method. Detailed description of each method is displayed in a table below:

Method	Description
SMS request	Function is activated when GH4000 receives a request : "psw<password> SPY". Exp.: <i>psw:0000;SPY</i> . If there is no password: <i>SPY</i> .
Action On Call	Function is activated when GH4000 receives a call from number, which is in <i>Action On Call</i> contact list and is configured to activate <i>Spy Call</i> function (for more detailed information see <i>Action On Call</i> chapter).

Operation

Number1 sends *SPY* SMS request or call to device (if action on call is configured from this number as *Spy Call* activation). Then GH4000 receives a message (or call) it increases a sensitivity of microphone and activates *SPY* call on the quit, *number1* starts listening what is happening around the device.

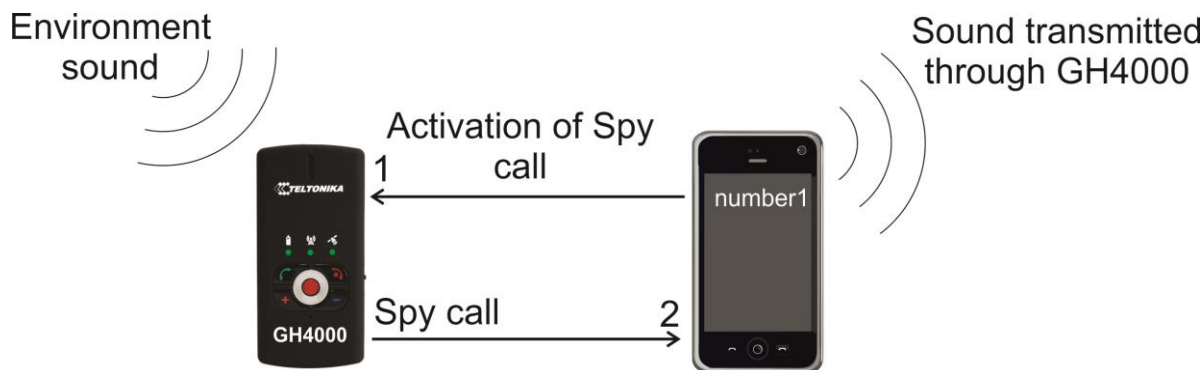

1 – SPY call is activated by SMS message or *Action On Call* method.

2 – GH4000 calls to *number1* and increases sensitivity of microphone, so *number1* can hear what is happening around the device.

Notice!

Spy call function can be deactivated just by terminating the call (like terminating ordinary conversation).

Minute Minder

It is a sound notification every minute during active conversation. It helps to determinate approximate conversation length.

Configuration

Minute Minder can be enabled in Track Assistant software: *Device configuration* → *GSM* → *Minute Minder*.

Operation

After GH4000 starts conversation every minute sound notification informs that one minute has passed.

Action on Call

Device functions can be activated by call. Incoming call is terminated instantly so user is not being charged for the call.

Number, which is chosen to control device, must be configured to use *Action on call* function. This entered number will be able to activate only one, configured function. Couple different numbers can control the same function. Five different numbers and actions can be used.

Configuration

Use Track Assistant software in order to configure this function:

1. Track Assistant → GSM → Action on Call;
2. Click on *Create new action*;
3. Enter parameters, which are described in a table.

Parameter	Description
Activation number	This number can activate chosen function.
Function	This function is activated when device receives a call from activation number. New field asking to enter SMS message format will appear if SMS function is chosen. Format can

be edited just by pressing *Edit SMS templates*.

Phone number Device call or send configured SMS (if this function was chosen) to this number.

Action on call*

[Create new action](#) [Delete all actions](#)

Activation number	<input type="text" value="+123"/>	Add contact	E.g. 1
Function	<input type="text" value="SMS"/>	<input type="text" value="Undefined SMS"/>	Edit SMS templates Delete this action
Phone number	<input type="text" value="+666"/>	Add contact	

Activation number	<input type="text" value="+321"/>	Add contact	E. g. 2
Function	<input type="text" value="Parking On"/>		Delete this action
Phone number	<input type="text"/>		

Selected action on call can be deleted by pressing on *Delete this action*. All actions can be deleted by pressing on *Delete all actions*.

For all available functions see *Keyboard configuration*. The only additional function is Spy (see *Silent call function*).

Operation

Number1 (activation number) calls to GH4000. GH4000 records an incoming call and compares it to numbers entered in *Action on call* list. When device finds that *number1* is in a list, it terminates an incoming call and activates function.

Operation:

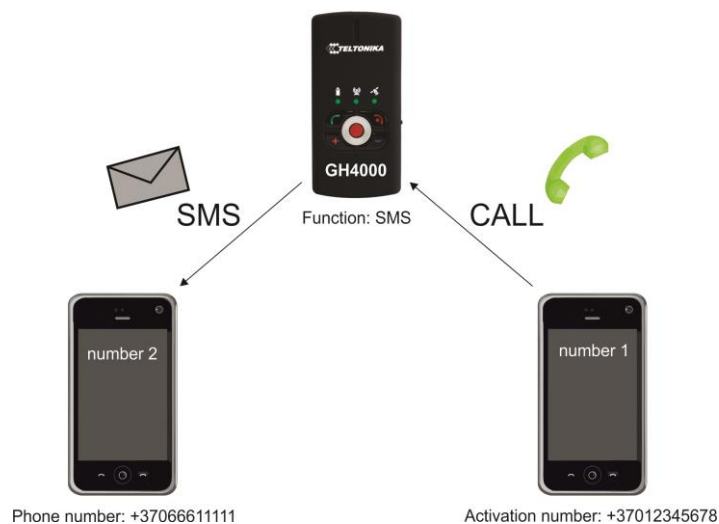

Function – send SMS to *number2*

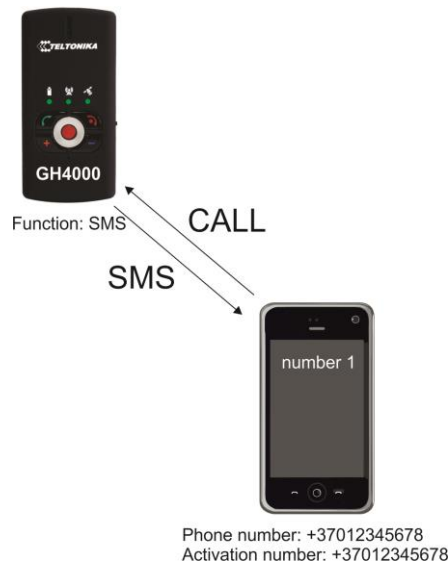

Function – send SMS to *number1* (same number)

Notice!

- 1) It will not be possible to make a voice call to device from number which is in Action On Call list.
- 2) Only last entered function will be activated if the same number is configured to activate a couple different functions.
- 3) Action on call function will work even if authorized number list is enabled and activation number is not in that list.

Auto Answer

This function enables automatic incoming call activation. It is handy when device owner is not able to answer the call himself.

Configuration

Auto answer function can be configured:

- 1. Device configuration → GSM → Auto answer;
- 2. Tick *Enable*;
- 3. Select value in *Answer after* tab.

Operation

Auto answer is set up to answer automatically after 3 rings. *Number1* calls to GH4000, device owner does not answer himself, so GH4000 automatically answers incoming call after 3 rings.

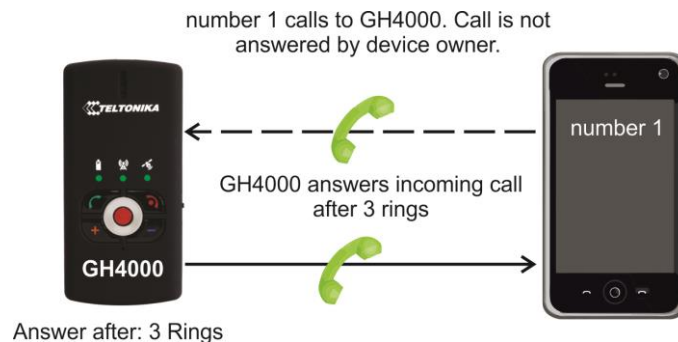

Roaming detection

This function enables periodical SMS sending while device is on roaming.

Roaming detection function can be enabled:

1. Device configuration → GSM → Roaming detection;
2. Tick *Enable*.

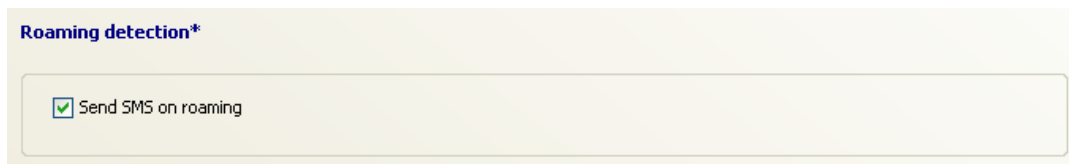

SMS requests

SMS requests can be used to get desired information and to control device by activating/deactivating certain functions.

Password

Password protection for SMS requests can be enabled/disabled. If request is protected with password, password must be typed before request with appropriate separation symbols.

Remember that symbol separating parameter *psw* and *password* is not important (*psw0000*), colon can be used too (*psw:0000*). Semicolon (;) is used to separate request from password. Here is an example of SMS:

psw:0000;Fix?

Do not type *psw* if there is no password. Just write a command. For example:

SMSTRACK ON

SMS request configuration

SMS request preferences can be found: *Device configuration* → *GSM* → *SMS requests*.

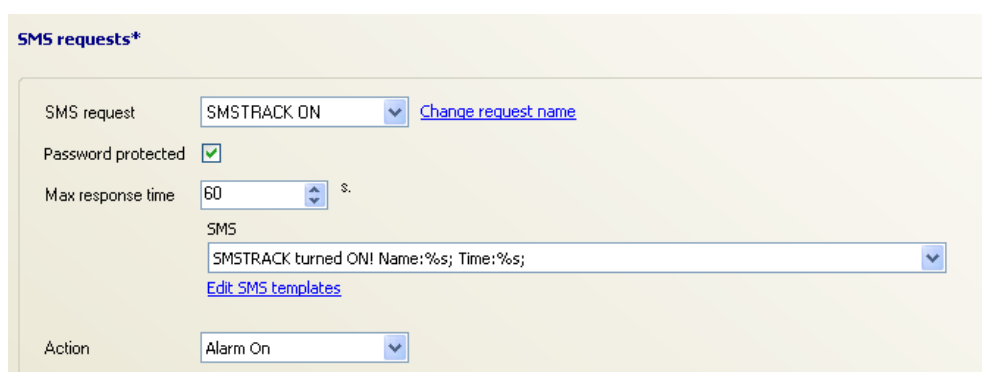

All configurable parameters are described in a table below:

Parameter	Description
SMS request	A name of SMS request. It is free to be changed.

<i>Password protected</i>	Enable/disable password protection for SMS requests.
<i>Max response time</i>	Maximum amount of time (in seconds) before responding to SMS. Different value can be set according to type of request. Max value is 3600s.
<i>SMS</i>	Format of the message the device will respond to request.
	Action which device will perform after receiving SMS request. Possible actions:
<i>None</i>	No action is performed.
<i>Alarm on</i>	Alarm mode is activated.
<i>Alarm off</i>	Alarm mode is deactivated.
<i>Alarm Call terminate</i>	This action stops cyclic calls when Alarm mode is set to Call (cyclic call) mode. Attention: alarm mode is not deactivated.
<i>Action</i>	
<i>SMS Track On</i>	SMS Track function is activated.
<i>SMS Track Off</i>	SMS Track function is deactivated.
<i>Send data through GPRS</i>	Data in device memory is being sent through GPRS.
<i>Power Off</i>	Turn off device.
<i>Reset</i>	Reset device.
<i>Parking On</i>	Parking function is activated.
<i>Parking Off</i>	Parking function is deactivated.

Device will always respond correctly to SMS request unless other restrictions (for example: authorized SMS) are enabled. SMS response is sent to the number device got request from.

If SMS request is configured to perform an action, device will perform this action immediately and will send a response after *Max response time*.

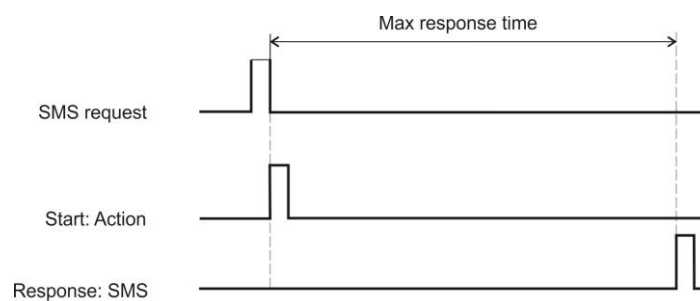

Operation of SMS request and respond

Notice!

If action, sent do device, is Reset or Power off and Max response time is 5s or more, device will not respond with message (except inf? request).

Device will respond to inf? request immediately, no matter what time is set in Max response time.

SMS information requests

Information can be obtained by sending an SMS information request to device. In SMS message text column SMS format is described in two ways: request is password protected (first one) and not protected (second one).

Request	SMS message text	Description
Information about the location of the device	psw:<password>;fix? fix?	Device will respond: FIX! Name: <device name>; Time: <local time>; Fix: <coordinates>; Alt: <altitude>; Sat: <visible satellites>; CellId: <GSM operator cell ID>; Angle: <movement angle>; Speed: <movement speed>; Device location can be determined after typing these coordinates to online map website (for example: Google Maps).
Information about the current state of the device	psw:<password>;inf? inf?	Device will respond: INF! Name: <device name>; Time: <local time>; Batlvl: <battery charge level>; Opld: <GSM operator recognition ID>; GSMSignlvl:<GSM signal level>; Prof:<>;ExtPower:<if device has external power>; IMEI:<device IMEI code>; Attention: Device will respond immediately, ignoring <i>Max response time</i> .
Information about Geozones	psw:<password>;geo? geo?	Device will respond with names of Geozones where it currently is : GEO! Name: <device name>; Time: <local time>;Geozone:<geozone1,geozone2...>;
The position of the device	psw:<password>;mn? mn?	Device will respond with information which can be displayed in a mobile phone (with internet connection).

Device sends data with last coordinates if it is unavailable to refresh it. Data of last coordinate is saved in a separate BAT RAM memory, which has its own power supply. Because of that data with last coordinate is not lost after turning off device or device reset. It can be lost only removing device battery or formatting device memory. In this case device will respond with <N/A> (Not Available) instead of <coordinate>. In order to change text <N/A>, see *N/A message*.

SMS management requests

Device operation can be changed using SMS requests. Certain functions can be activated/deactivated (see table below). In SMS message text column SMS format is described in two ways: request is password protected (first one) or not protected (second one).

Request	SMS message text	Description
SMS tracking function	psw:<password>;SMSTRACK ON	Activate SMS track function.

	smstrack on	
	psw:<password>;SMSTRACK OFF	Deactivate SMS track function.
	smstarck off	
Alarm function	psw:<password>;ALARM ON	Activate Alarm function.
	alarm on	
	psw:<password>;ALARM OFF	Deactivate Alarm function.
	alarm off	
Termination of the call	psw:<password>;TERMINATE	Termination of the call.
	terminate	
Spy call	psw:<password>;SPY	Activate SPY function.
	spy	
Device reset	psw:<password>;RST	Reset device.
	rst	

It is possible to combine different requests in one SMS. In order to send requests correctly, please follow typing construction:

psw:<password>;<request1>;<request2>;<request3>

Example:

psw:0000;fix?;geo;alarm on

Connections and data

Periodical and alarm data can be collected and stored in the memory or to be sent to server using GPRS. GPRS connection can be configured: *Device configuration* → *Tracking and Saving* → *GPRS*.

GPRS

Enable GPRS

Hold server connection alive

GPRS send period s GPRS send period on stop

Send data on roaming

Parameter	Description
<i>Enable GPRS</i>	Enable/Disable GPRS.
<i>Hold server connection alive</i>	Enable/Disable function, which allows you to hold connection with server in order not to reconnect every time. It is recommended if data sending period is less than 30s.
<i>GPRS send period on stop</i>	Enable/Disable periodical data sending and set sending period when device is idle. Maximum period is 86400s.
<i>GPRS send period</i>	Enable/Disable periodical data sending and set sending period. Maximum period is 86400s.
<i>Send data on roaming</i>	Enable/Disable data sending when device is on roaming.

Server

Server information must be entered in order to send data using GPRS. These parameters can be configured: *Device configuration* → *Connections and data* → *Server*.

Parameter	Description
Server	
<i>Server address</i>	Server (remote computer) address. IP or DNS address can be filled in. Example: avl3.teltonika.lt server address is 212.47.99.61.
<i>Server port</i>	Server port number. Maximum number 65535 How to find port number see <i>FAQ</i> .
<i>Protocol</i>	Data sending protocols. Device supports: TCP/IP and UDP. More about these protocols can be found here: www.en.wikipedia.org/wiki/TCP/IP www.en.wikipedia.org/wiki/UDP
<i>noACK</i>	If this function is enabled, device sends data to server without confirmation. It depends on server configuration.

Access point name (APN)	
<i>Create new APN</i>	Press in order to create new access point name (APN).

Authentication type

If there is no authentication select *none*. Your network operator will provide which type of authentication to choose. Two types are possible:

- *PAP* (Password Authentication Protocol) – password requiring most common authentication.
- *CHAP* (Challenge Handshake Authentication Protocol) – more complex authentication type.

APN stands for access point name and is important when establishing connection through GPRS. APN is provided by network operator. When device tries to connect to internet, network provider, depending on a given APN will give a device certain way to reach internet connectivity. If APN tab is kept blank, device can succeed trying to connect using APN – internet or without any APN. In order to ensure internet connection it is recommended to fill APN tab in. Your network provider will gladly give this information. Device can store 4 APN addresses.

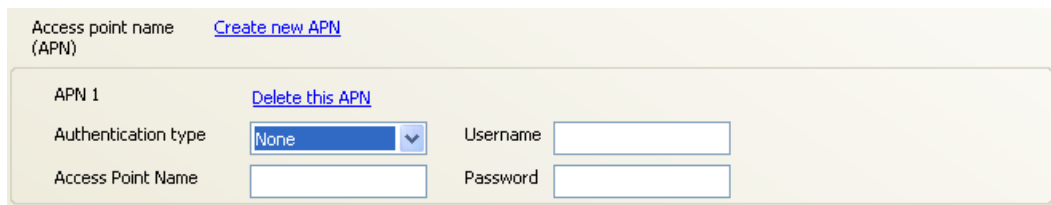

Access point name (APN) [Create new APN](#)

APN 1 [Delete this APN](#)

Authentication type: None Username:

Access Point Name: Password:

Communication with the server

After given time device connects to server using GPRS and sends its unique IMEI code. Server confirms device log-in. Right after that device sends data in packets and after every packet server sends confirmation if data is received correctly.

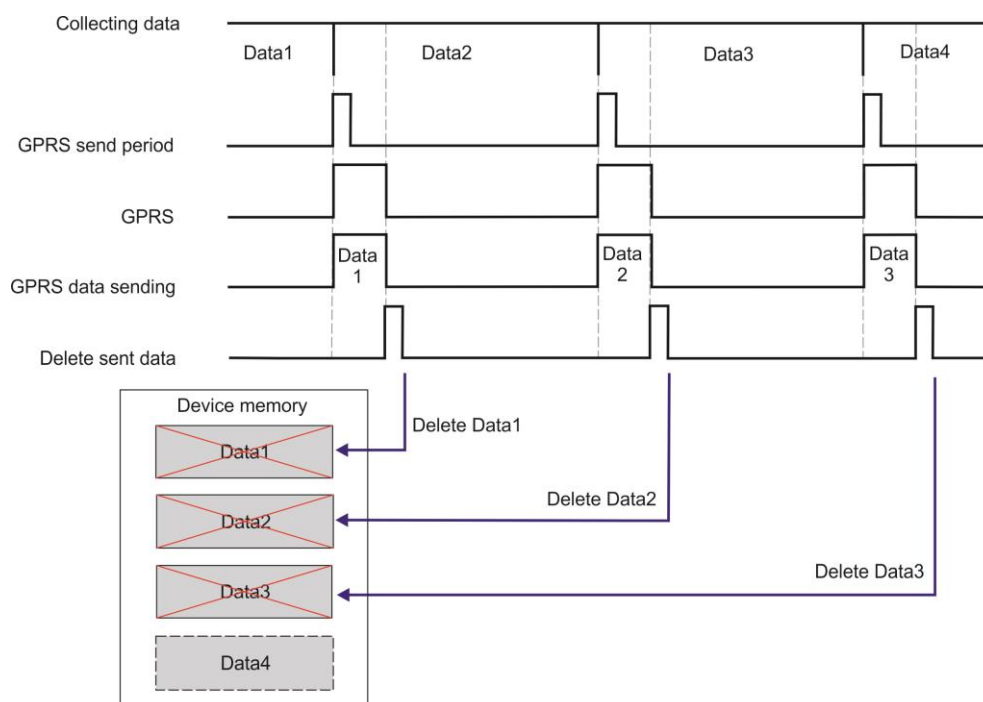

Periodical data saving: after given time to send data, device connects to server through GPRS and sends data. Right after that device deletes sent data.

When device fails to send data, it does not delete data and tries to send it when the next period comes:

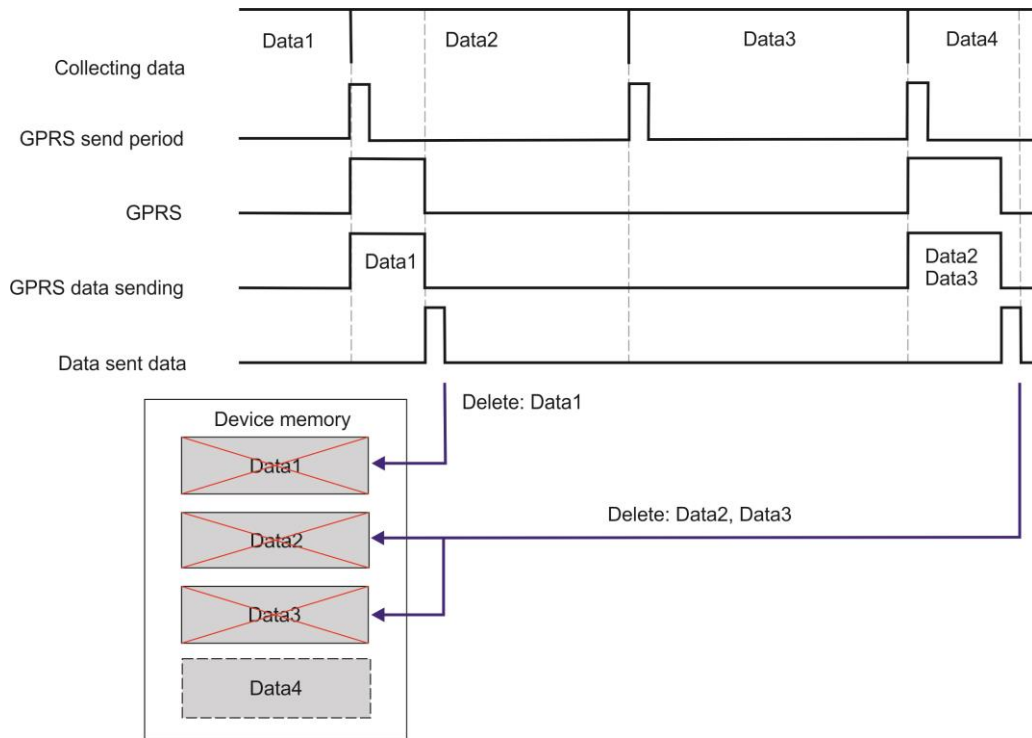

Periodical data sending when device fails to send data (Data2)

If data is sent very often, device has to connect to server very often. In order to avoid often connectivity, *Hold server connection alive* parameter should be enabled.

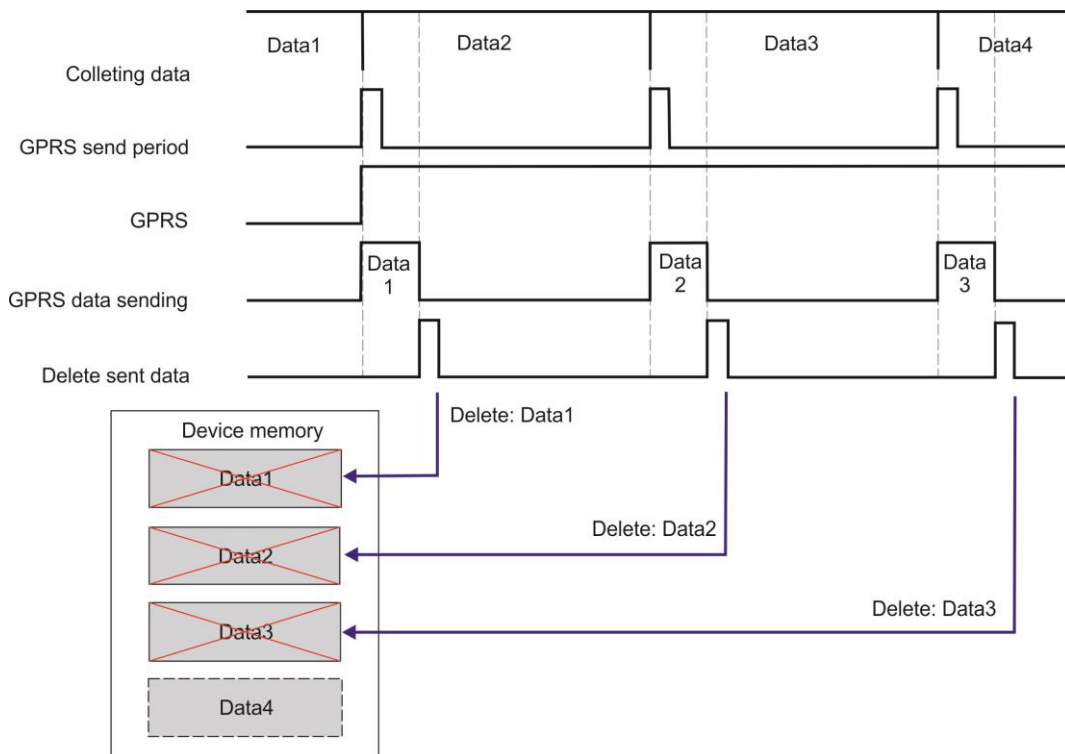

Periodical and alarm data

Periodical data can be collected and stored in the memory to read later or can be sent using GPRS (Packet Radio Service) to server. You can choose various types of data to be saved periodically: *Device configuration* → *Connections and Data* → *Periodical and alarm data*. Periodical data saved to memory by default: longitude, latitude, altitude, speed, satellites. If data transfer is configured, every time data is successfully transferred to server, the storage is deleted and ready to save new data.

The screenshot shows a configuration window with three main sections: 'Save data to the memory', 'Data sending order', and three data selection tables.

Save data to the memory: Radio buttons for 'When location available only' (selected), 'Always', and 'Last location when GPS FIX unavailable'.

Data sending order: Radio buttons for 'Newest first' and 'Oldestfirst' (selected).

GPS info table:

Alarm	Periodical	Parameter
<input checked="" type="checkbox"/>	<input checked="" type="checkbox"/>	Latitude, Longitude
<input checked="" type="checkbox"/>	<input checked="" type="checkbox"/>	Altitude
<input type="checkbox"/>	<input type="checkbox"/>	Angle
<input checked="" type="checkbox"/>	<input checked="" type="checkbox"/>	Speed
<input checked="" type="checkbox"/>	<input checked="" type="checkbox"/>	Satellites
<input type="checkbox"/>	<input type="checkbox"/>	HDOP
<input type="checkbox"/>	<input type="checkbox"/>	VDOP
<input type="checkbox"/>	<input type="checkbox"/>	PDOP
<input type="checkbox"/>	<input type="checkbox"/>	Movement
<input type="checkbox"/>	<input type="checkbox"/>	Time to fix
<input type="checkbox"/>	<input type="checkbox"/>	GPS Coordinate Time

GSM info table:

Alarm	Periodical	Parameter
<input type="checkbox"/>	<input type="checkbox"/>	GSM Cell ID
<input type="checkbox"/>	<input type="checkbox"/>	Signal quality
<input type="checkbox"/>	<input type="checkbox"/>	Operator code
<input type="checkbox"/>	<input type="checkbox"/>	Roaming

Device info table:

Alarm	Periodical	Parameter
<input type="checkbox"/>	<input type="checkbox"/>	Battery, %
<input type="checkbox"/>	<input type="checkbox"/>	Battery, mV
<input type="checkbox"/>	<input type="checkbox"/>	USB
<input type="checkbox"/>	<input type="checkbox"/>	Live
<input type="checkbox"/>	<input type="checkbox"/>	Button ID
<input type="checkbox"/>	<input type="checkbox"/>	Alarm activation cause

Alarm data is sent in case alarm was activated. Data can be chosen: *Device configuration* → *Connections and Data* → *Periodical and alarm data*. In order to send alarm data it has to be configured using Track Assistant software: *Device configuration* → *Connection and Data* → *GPRS and Server columns*.

The screenshot shows the same configuration window as above, but with different selections in the data selection tables.

Save data to the memory: Radio buttons for 'When location available only' (selected), 'Always', and 'Last location when GPS FIX unavailable'.

Data sending order: Radio buttons for 'Newest first' and 'Oldestfirst' (selected).

GPS info table:

Alarm	Periodical	Parameter
<input checked="" type="checkbox"/>	<input checked="" type="checkbox"/>	Latitude, Longitude
<input checked="" type="checkbox"/>	<input checked="" type="checkbox"/>	Altitude
<input type="checkbox"/>	<input type="checkbox"/>	Angle
<input checked="" type="checkbox"/>	<input checked="" type="checkbox"/>	Speed
<input checked="" type="checkbox"/>	<input checked="" type="checkbox"/>	Satellites
<input type="checkbox"/>	<input type="checkbox"/>	HDOP
<input type="checkbox"/>	<input type="checkbox"/>	VDOP
<input type="checkbox"/>	<input type="checkbox"/>	PDOP
<input type="checkbox"/>	<input type="checkbox"/>	Movement
<input type="checkbox"/>	<input type="checkbox"/>	Time to fix
<input type="checkbox"/>	<input type="checkbox"/>	GPS Coordinate Time

GSM info table:

Alarm	Periodical	Parameter
<input type="checkbox"/>	<input type="checkbox"/>	GSM Cell ID
<input type="checkbox"/>	<input type="checkbox"/>	Signal quality
<input type="checkbox"/>	<input type="checkbox"/>	Operator code
<input type="checkbox"/>	<input type="checkbox"/>	Roaming

Device info table:

Alarm	Periodical	Parameter
<input type="checkbox"/>	<input type="checkbox"/>	Battery, %
<input type="checkbox"/>	<input type="checkbox"/>	Battery, mV
<input type="checkbox"/>	<input type="checkbox"/>	USB
<input type="checkbox"/>	<input type="checkbox"/>	Live
<input type="checkbox"/>	<input type="checkbox"/>	Button ID
<input type="checkbox"/>	<input type="checkbox"/>	Alarm activation cause

Configuration

In order to use GPS data, GPS must be enabled: *Device configuration* → *Tracking and Saving*.

If data transfer to server is required you have to configure it using Track Assistant software: *Device configuration* → *Connection and Data* → *GPRS and Server columns*.

Parameter	Description
	<i>When location available only</i> – saves data only when location is available.
	<i>Always</i> – always saves data. It does not matter if coordinate was found or not. In this case N/A (Not Available) will be displayed over coordinate.
<i>Save data to the memory</i>	<i>Last location when GPS FIX unavailable</i> - The new data saving method saves record with real coordinates if the device has GPS fix at that moment. If GPS fix was acquired but lost, the device saves record with last coordinates. If GPS fix wasn't acquired and the device doesn't have last coordinates the record will not be made.
	Specifies the manner in which data is sent through GPRS.
<i>Data sending order</i>	<i>Newest first</i> – newest data will be sent first.
	<i>Oldest first</i> – oldest data will be sent first.
<i>GPS, GSM, Device info</i>	In these fields you can choose what information in case of emergency (Alarm) or periodically will be saved.

There are three main information categories: GPS information, GSM information and Device information.

Operation

If periodical data saving is enabled, device saves data to memory after time set in logging period (*Device configuration* → *Tracking and Saving*). Data is related to coordinate, so before saving data to memory, coordinate must be found. Then there is time to save a record device turns on GPS module and searches for coordinate for given time. If coordinate is:

- 1) Found before timeout, device turns off GPS module and writes coordinate to memory;
- 2) Not found, device turns off GPS module and writes N/A to memory (if *Save data to the memory* is chosen to *Always*) or does not write at all (if *When location available only* is chosen).

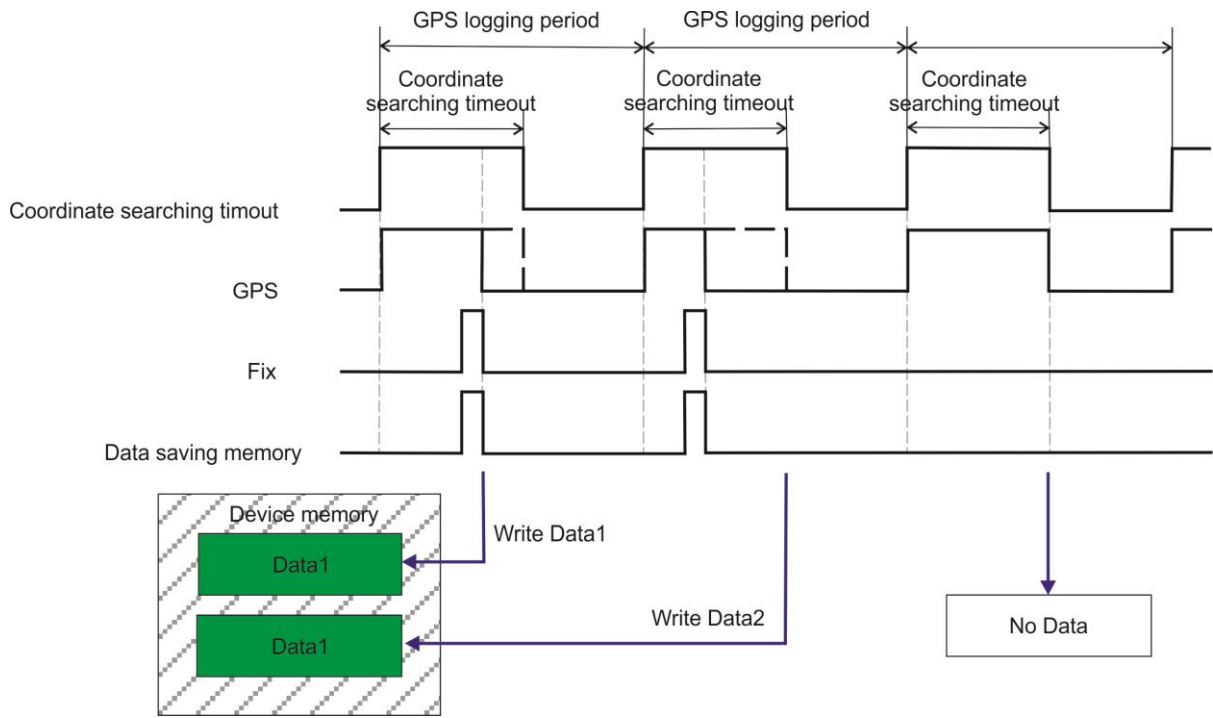

Periodical data saving, when data is saved after coordinate is found (*When location available only*)

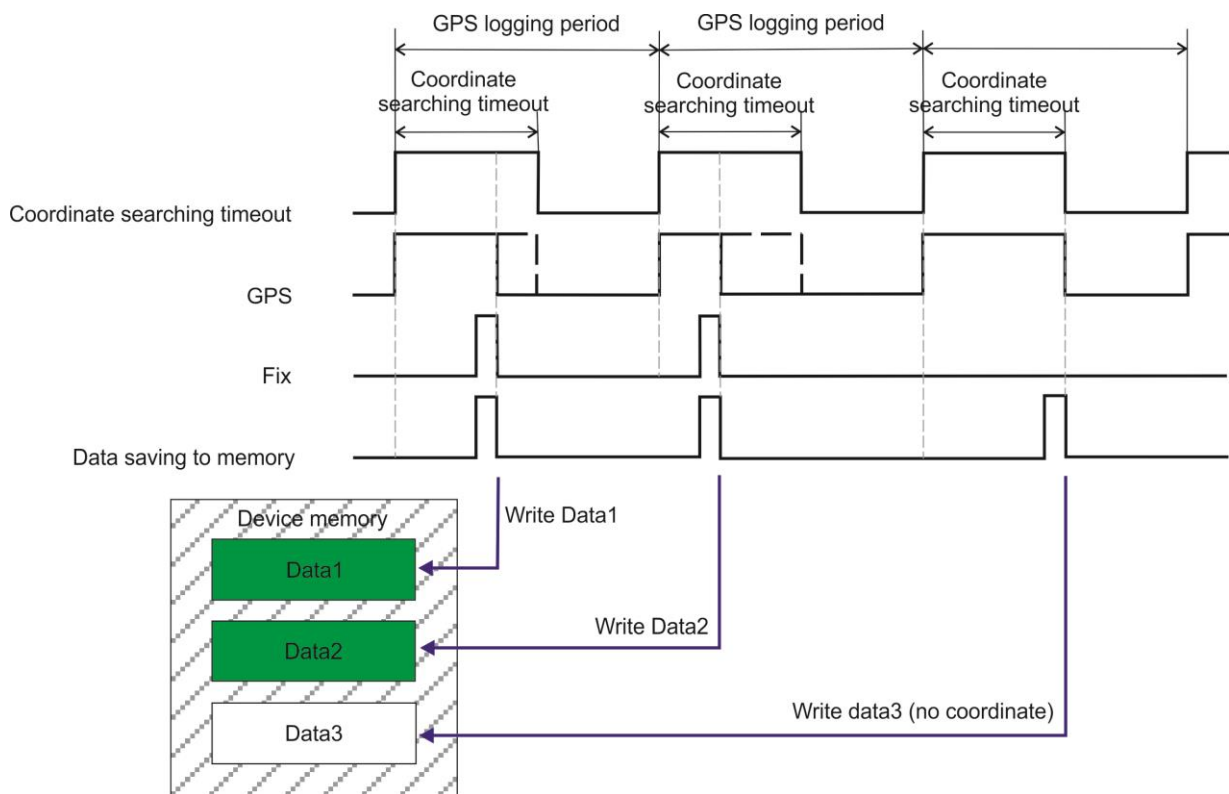

Periodical data saving, when data is saved always (*Always*)

Other parameters are described in *Tracking and Saving*.

Notifications

Sound notifications are widely used. It notifies about incoming calls, SMS messages, turning on/off device, low battery level and etc. Some of sound notifications can be configured. Configuration Sound notifications can be configured in Track Assistant software: *Device configuration* → *Notifications* tab.

Parameter	Description
	<i>Ring level</i> – selected ring tone volume.
<i>Sound and Speaker</i>	<i>Speaker level</i> – selected speaker volume.
	<i>Ringing tone</i> – selected ring tone.
<i>SMS notifications</i>	<i>Incoming SMS notification</i> – enable/disable incoming message notification.
	<i>Out coming SMS notification</i> – enable/disable outgoing message notification.
<i>Alarm</i>	<i>Enable PreAlarm</i> – enable/disable PreAlarm sound notification.
<i>Parking</i>	<i>Enable parking</i> – enable/disable parking sound notification.

Sound notifications which are not configurable:

- 1) Device turning on/off;
- 2) Function activation/deactivation;
- 3) Error determination (example: SIM card is not inserted).

Melodies of Sound Notifications

When GH4000 is connected to terminal (example: Hyper Terminal) via USB cable it is available to listen to melodies. Terminal settings: Baud rate: 19200, PORT: COM1 (how to find port number see *FAQ*), Data bits: 8, Parity: none, Stop bits: 1, Flow control: none, DTR/RTS: off. When type #GH+tone=*melody code*. Codes are displayed in a table below.

Type of melody	Playing code
Device turn on	16C5,16F#4,16P,8F4,32F#4,8P,8E4,4P,4G4,8P,16C5,2P,2C5;
Device turn off	4E4,16P,8G4,2P,4B4,4P,16C5;
Function activation	8A4,8P,16C5;
Function Deactivation	4E4,32P,16C4;
Error determination	32F4,32P,32F4,32P,32F4,32P,32F4,32P,32F4,32P,32F4,32P,32F4,32P,32F4;
Received SMS message	16C4,16E4,16G4,8C5,4P,16C4,8C4,2C5;
Sent SMS message	16C4,16E4,8C5;
PreAlarm	32C5,32P,32C5,32P,32C5,32P,4C5,32P,4C5,32P,4C5,32P,32C5,32P,32C5,32P,32C5;
Battery Low (critical) level	16B4,8G4,32P,1C4;
Pressed button	32C5,32C4;

Example: #GH+tone=16C4,16E4,8C5.

Vibration

Vibration is one of notifications types. It informs about incoming call, received/sent SMS message or activated Alarm.

Configuration

Indication can be configured in Track Assistant software: *Device configuration* → *Notifications* → *Vibration*.

Vibration can be enabled or disable for these GH4000 functions:

Parameter	Description
On Call	Device will vibrate when receiving an incoming call.
On SMS Incoming and Out coming	Device will vibrate after SMS message is received or sent.
Vibration on Alarm event	Device will vibrate after Alarm function is activated.

Battery notifications

Battery notifications can be configured using Track assistant software: *Device configuration* → *Notifications* → *Battery* tab. Configuration parameters are listed in a table below.

Operation

Device constantly monitors battery charge level. If SMS *Battery charge level becomes lower than X% or battery fully charges* notification is enabled device will inform by sending SMS message when charge level is lower than determined or when battery is fully charged.

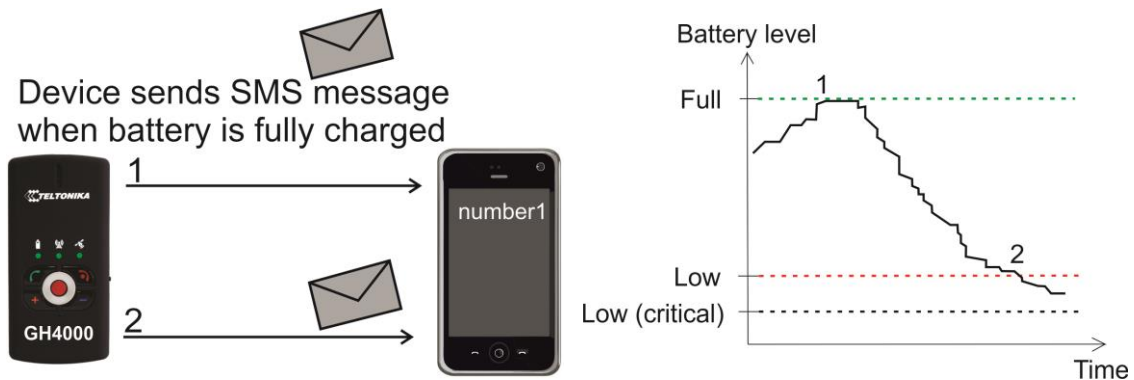

Parameter	Description
<i>Low battery indication</i>	<i>Enable</i> – enable/disable low battery sound notification.

Battery charge level (%) – set up the lowest limit of battery charge level (percentage). Sound notification will be started after battery charge level will be lower than determined.

Warning repeat period – time period, describing how often a sound notification will be repeated. Min period: 1 min, max period: 1000 min.

Disable –disable SMS notification

Battery charge level becomes lower than X% – enable SMS notification when battery charge level will be lower than determined (charge level X is selected in *Battery charge level*).

Battery charge level becomes lower than X% or battery fully charges – enable SMS notification when battery charge level will be lower than determined (charge level X is selected in *Battery charge level*) or is fully charged.

Battery notification by SMS

Battery charge level (%) – set up the lowest limit of battery charge level (percentage).

SMS format Bat Low – select a format of SMS that will be send in case battery level is lower than determined.

SMS format Bat Full – select a format of SMS that will be send in case battery is fully charged.

Edit SMS templates – format of notification SMS can be edited (*Bat Low* and *Bat Full* separately).

Phone number

Add contact – select a contact, which will receive notifications by SMS.

Security

SIM PIN and PUK codes

PIN code is used when SIM card protection is needed. When SIM, protected with PIN code, is inserted into device, it is not available to use SIM card if PIN code is not entered and GH4000 GSM LED will flash red. PIN code can be removed using mobile phone.

Configuration

PIN code can be entered in Track Assistant software: *Device configuration* → *Security* → *PIN code section*. PIN code can be entered by pressing on *Enter PIN or PUC code*. *Status* shows current status of SIM card's PIN code.

Status	Description
<i>Not required</i>	PIN code is not needed.
<i>PIN code entered but not saved in configuration</i>	PIN code is entered but not saved in configuration.
<i>PIN not required or entered OK</i>	PIN code is not needed or entered correctly.
<i>Required PIN or entered BAD PIN</i>	PIN code is required or it was entered incorrectly.

PIN code can be entered in a table which pops up when device is connected to Track Assistant software. Table pops up when PIN code is required and is entered incorrectly or does not entered at all.

Device automatically enters PIN code if correct PIN code was entered and saved to configuration before. If PIN code is entered incorrectly 3 times SIM card is blocked. In order to unblock SIM card use your mobile phone or Track Assistant software to enter PUK code, which consist of 8 digits (PUK is provided with SIM card). Table, asking to enter PUK code and new PIN code, will pop up two times when GH4000 will be connected to Track Assistant software.

Notice!

Do not forget to save configuration when PIN code is entered. Also do not forget that SIM card's PIN code will have to be entered every time when different SIM card is inserted.

Operation

SIM card with PIN code protection is inserted into device and it indicates GSM error. GH4000 is connected to Track Assistant software to enter correct PIN code. After configuration is saved, device starts searching for operator and works properly after device is reset.

Device password

This function allows user to protect device configuration by asking password every time configuration is read or tried to be changed. This password will be also required when sending SMS requests or configuration SMS.

By default password is 0000. Maximum length of the password is 32 characters.

Configuration

Password will be asked every time after device reset and when it is connected to Track Assistant software.

Device password can be changed in Track assistant (*Device configuration* → *Security* → *Device password* tab) by pressing *Change password* and typing new password two times.

The only way to remove password is to send this SMS message to device:

psw0000 ch

Operation

- 1) Connect GH4000 to Track Assistant software and choose *Device configuration* tab. You will be asked to enter password. In order to be able to change configuration, enter password.

2) Request or configuration SMS format is: „psw**** command“. SMS message is ignored if wrong password is entered.

Examples:

- SMS request: psw:0000;smstrack on;
- Group request: psw:0000;spy;Fix?;
- Configuration SMS: psw0000 battery +37066611111;
- Configuration extended SMS : psw:0000;CFG1;GSM:1,60,1;RST.

Steps to activate password for SMS requests:

- 1) *Device configuration* → *GSM* tab → *SMS requests*;
- 2) Select *Password protected*.

Example:

SMS request is password protected: psw:0000;inf?

SMS request is not password protected: inf?

Notice!

It is allowed to type wrong password in Track Assistant software only 5 times. Device will be blocked after fifth time. Now you will need RPC code (Remove Password Code). RPC code is located on GH4000 package, near IMEI code. To enter RPC code on GH4000 has to be inserted SIM card with removed PIN code. If you lost your package, please contact your sales manager. RPC code can be entered wrongly 20 times. After 20th time device will be blocked, in order to unblock GH4000 firmware must be rewritten.

GSM security

SMS security

This function allows user to control request SMS messages by sending response from device to only those numbers that are included into authorized number list.

Configuration

This function is configured in Track Assistant software *Device configuration* → *Security* tab → *GSM security* → Select *Enable SMS security*.

This field is for authorized incoming SMS only. Detailed information about additional functions is displayed in a table below:

Parameter	Description
<i>Enable SMS security</i>	Enable/disable authorized contact list.
<i>Add contact</i>	Press in order to add new contact to authorized contact list.
<i>Delete</i>	Press in order to delete contact from authorized contact list.

Operation

SMS security is enabled. *Number2* is in an authorized number list while *number1* is not:

- 1) GH4000 receives a message from *number2*. Device accepts the message and responds.
- 2) GH4000 receives a message from *number1*. Device rejects the message and do not respond.

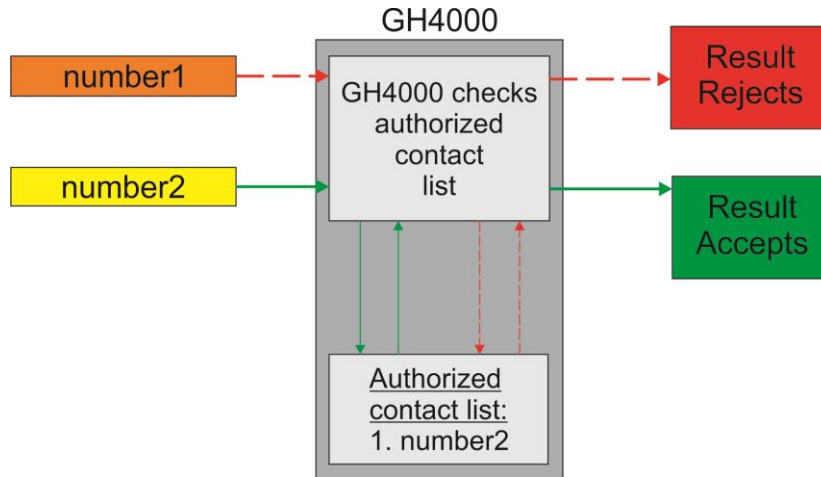

Operation of GH4000 when SMS security is enabled

Notice!

Maximum 10 numbers can be added to Authorized contact list.

Call security

This function allows user to control incoming calls by accepting only those calling numbers, which are included into authorized number list.

Configuration

This function can be configured in Track Assistant software: *Device configuration* → *Security* tab → *GSM security* → select *Enable calls security*.

Authorized contact list is configured in this field. Detailed explanation is described in a table below:

Parameter	Description
<i>Enable calls security</i>	Enable/disable authorized contact list.
<i>Add contact</i>	Press in order to add a new contact to authorized contact list.
<i>Delete</i>	Press in order to delete contact from authorized contact list.
<i>Up/Down</i>	Number distribution can be changed.

Operation

Call security is enabled. *Number2* is included into authorized number list while *number1* is not:

- 1) GH4000 receives a call from *number2*. Device accepts the call and is able to answer it.
- 2) GH4000 receives a call from *number1*. Device denies the call and is unable to answer it.

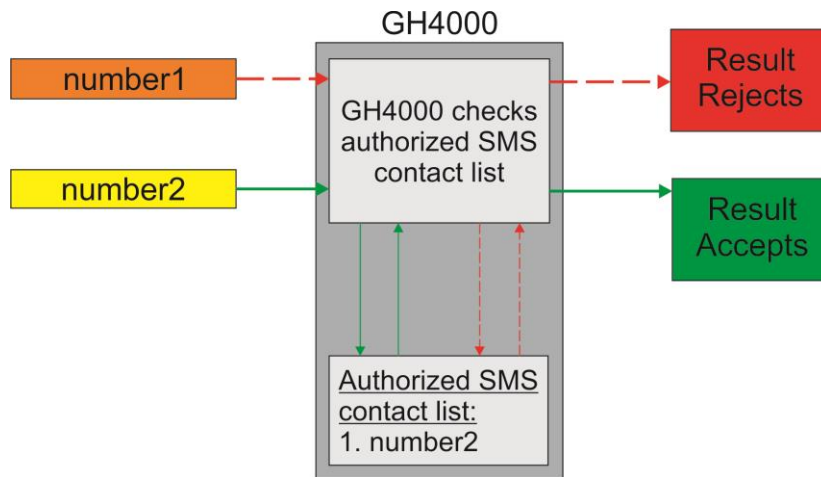

Operation of GH4000 when call security is enabled

Notice!

- *Maximum 10 numbers can be added into authorized contact list.*
- *Action On Call function will be activated regardless of whether the caller is in the authorized contact list or not.*

Date and time

Configuration

Time can be configured in Track Assistant software: *Device configuration* → *Date and Time*.

Parameter	Description
Time	Computer Local Time – displays current time.
	Device Time – displays device time.
Computer local time	
Time offset	Device works on UTC (GMT0) time. So difference between local which is shown by computer and UTC time must be entered here. This difference is used to change UTC time to local time automatically.
Device Time	
Time zone	Time zone selection.
Time format	Time format can be changed by changing the sequence of letters: Y – years, d – days, m – months, H – hours, M – minutes, S – seconds.
Daylight saving	Time when device starts using winter time (Start) and goes back to summer time (End) can be set here.

<i>Enable</i>	Turns daylight saving on.
<i>Disable</i>	Turn daylight saving off.
<i>Delta</i>	Time difference between winter and summer time.
<i>Start</i>	Date and time when winter time starts.
<i>End</i>	Date and time when winter time ends.

Operation

Factory set time (2008.01.01) is used until device gets first fix. Device gets time information (UTC (GMT0) from satellites when it is placed under clear sky). Time zone can be changed sending SMS or using Track Assistant (*Device configuration* → *Date and Time* → *Time zone*). Device recalculates satellites time depending on configuration and uses new local time.

System

Actuation by external power

This function allows user to use device instantly after it was plugged into external power source or connected to computer via cable.

Configuration

This function can be configured in Track Assistant software: *Device configuration* → *System* → *Actuation by external power*.

Operation

- 1) *Actuation by external power* is configured when device's battery runs down and GH4000 turns off;
- 2) As soon as device is connected to external power source it turns on and starts functioning as it was configured;
- 3) If *Actuation by external power* function is turned off, device does not turn on after it is connected to external power.

N/A message

It is a message text sent, when requested parameter is not available.

Configuration

This message can be configured in Track Assistant software: *Device configuration* → *System* → *N/A message*. By default this text is "N/A".

Reset to factory settings

It is a function that lets to reset device to factory settings. Configuration can be reset and all data can be deleted: *Device configuration* → *System* → *Reset to factory settings* → *Delete all data from device* → *Reset to factory settings*. If data is wanted to be used later than *Delete all data from device* has not to be ticked.

Firmware update

Firmware update is performed using Track Assistant software.

First of all GH4000 has to be switched to Firmware installation mode. To do this, follow these steps:

1. Press and hold green  button and while holding it shortly press reset button (paperclip is suitable for this). Make sure GH4000 is in Firmware update mode (battery's (1) and GSM's (2) LED s should light up green).

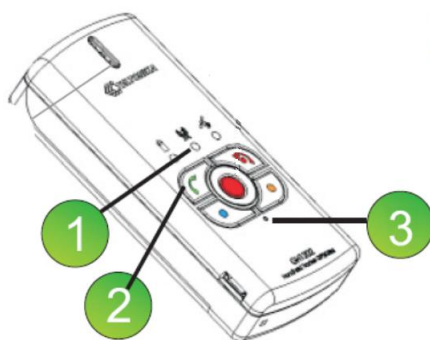

- 1 – Indicators (1 and 2 LED's has to light up)
- 2 – Keyboard button 1 (green)
- 3 – Reset Button

Further steps are performed using Track Assistant software in *Firmware* tab:

2. Select *Firmware* table and choose newest .BIN format file needed for firmware update.
3. Choose port number to which GH4000 is connected to (how to find port number see *FAQ*). If port is not available reconnect device and click on a refresh button and select it from available ports. If the list contains more than one port, remember these ports before reset.
4. If the device is ready click START button to begin firmware installation.
5. After successful firmware update „Transmission ended OK! Please restart device!“ should appear in the last lines in *Log* section.

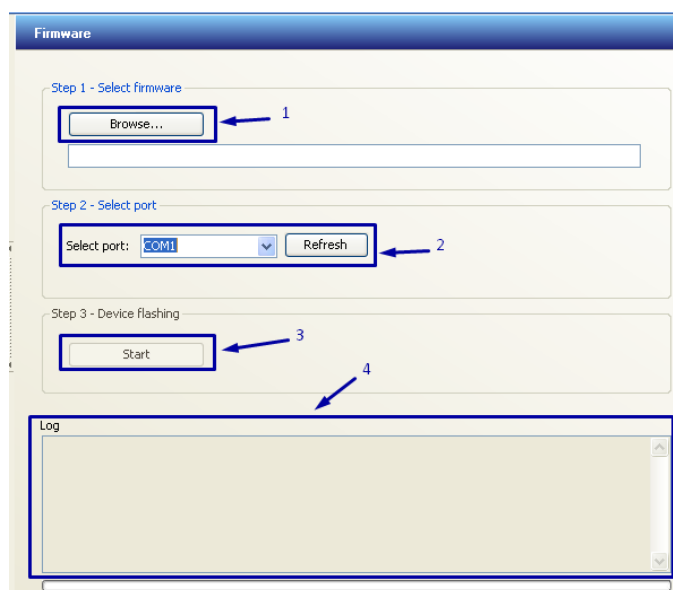

GH4000 battery's LED should light up green, GSM's and GPS's LEDs should blink green light.

6. Reset device.
7. After firmware update it is recommended to delete device memory. In order to do that, please use Terminal software (Terminal software can be downloaded from here: <http://av11.teltonika.lt/downloads/GH4000/Software/Terminal>). Connect GH4000 to Terminal and type following commands:



















1) #GH+PSW=0000

- 2) #FORMAT
- 3) #DEFAULT
- 4) #RST
- 5) Program should respond 'OK' to all the commands.

Notice!







Please be aware that it will take more time to get first coordinate after firmware is updated.

LEDs indication

	 Battery	 GSM	 GPS/Alarm
Device is ready for firmware update			
Device is not ready for firmware update, USB data cable error			
Firmware update in progress			
Firmware successfully updated			
Firmware error! It is deleted or damaged			

Types of errors and their solution

If firmware of the device has been damaged or removed it can be rewritten again.

	 Baterija	 GSM	 GPS/Pavojus
Firmware error! It is deleted or damaged			

In this situation, device must be reconnected to computer. After reconnecting device the firmware update procedure can be started again.

Monitoring

In order to monitor and analyze GH4000 tracks with comfort it is available to depict data in a map.

Configuration

Map can be configured in Track Assistant: *Device configuration* → *Monitoring*. All available options and tabs' description are displayed in a table below.

Parameter	Description
-----------	-------------

1. Find	A search between all saved record files in your computer. You can enter here file name or device's IMEI.
2. From/to	Filters files' search by date.
3.(Name/Created/Locations/IMEI)	In this table are listed all saved files that meet the specified search.
4. Local time	If this tickbox is ticked records are shown in local time.
5. Min. distance	Records can be filtered by min distance between two record points. It is handy to see moving track and when many records are made in one location.
6. From/to	Filters points by date.
7. Apply	In order to apply filters (Local time/Min.dist./date) it is important to press <i>Apply</i> .
8. Device	Chosen records are read from connected device.
➤ Periodical points	Only periodical points are read from device.
➤ Alarm points	Only alarm points are read from device.
➤ Clear alarm points	Clears all alarm points from device (it is not available to use it later).
➤ Clear periodical points	Clears all periodical points from device (it is not available to use it later).
➤ Clear all points	Clears all (periodical and alarm) points from device (it is not available to use it later).
9. Open	Opens saved file (.XML).
10. Save	Saves from device read points to file (in order to read it later).
➤ Save To Storage	Saves as <i>Track Assistant</i> file.
➤ Save To Track log file	Saves as separate file in chosen directory in .XML format.
➤ Save To CSV file	Saves to CSV format. It is handy to use in a different maps.
➤ Save To KML file	Saves to KML format. This format is used by <i>Google maps</i> .
11. Google Earth	Displays records in <i>Google Earth</i> software's map (see <i>Google Maps</i>).
12. Show track	Shows points (read from device or opened file) on <i>OpenStreetMap</i> map (used by default in <i>Track Assistant</i> software).
13. Clear track	Clears <i>OpenStreetMap</i> map.
14. Map	<i>OpenStreetMap</i> map is used by default in <i>Track Assistant</i> software, but it is available to use different map.
15. View location on map	Shows any location on map by entered coordinates (latitude, longitude).

Shows map in full screen. To exit full screen click on *ExitFullScreen* on the right top corner of map or press *Esc* on Your keyboard.

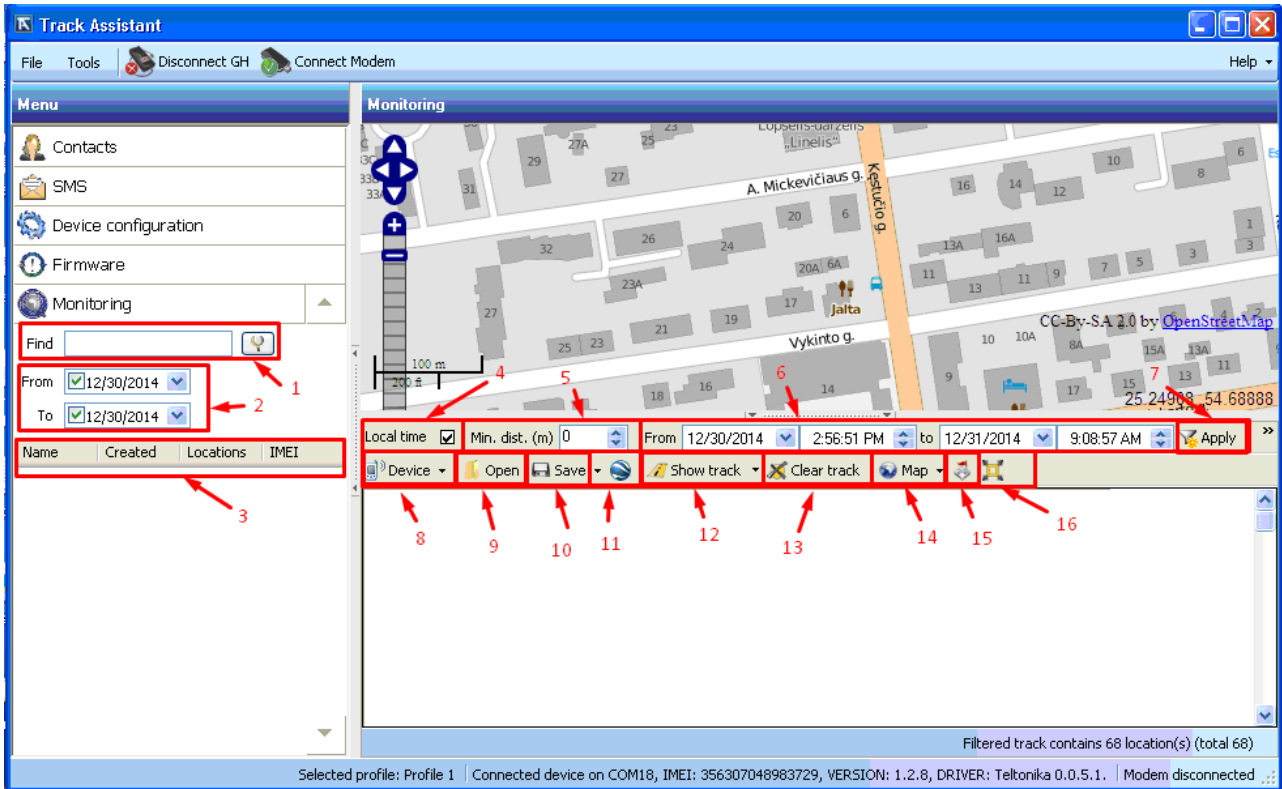

Google Maps

This is a digital map created by Google. The use of this map is limited, so there is no possibility to use it in Track Assistant software. In order to display traveled distance just press button *Open Google Earth* (KML file) or save coordinates to .KML format file and after that open it in Google Earth software. For both methods Google Earth software is needed. This software is free of charge and can be downloaded from here: <http://www.google.com/earth/download/ge/agree.html>.

Also .KML files can be viewed using internet browser after opening this link:

<https://www.google.com/maps/d/splash?app=mp>. Guide how to do this can be found here:

<https://support.google.com/mymaps/answer/3024937?hl=en>.

Notice!

Please refer to us, to get more information about maps which can support Track Assistant we could be glad to help you.

Configuration using SMS messages

GH4000 has unique ability to communicate using SMS without any physical connection. Device configuration can be changed using SMS messages. There are two types of configuration: fast (easy) and advanced configurations. Device after receiving this type of message will respond with the answer or by activating/deactivating a function. Remote device configuration is very handy and extends device usability. There are three types of messages: fast, advanced and requests. It is not important capital or not is used when typing the message (accepts password).

Easy configuration

This type of configuration is for beginners. Precise SMS message formats are written below. If an SMS command has been received and accepted then the device will reply with a special confirmation SMS, otherwise the device will not reply at all.

Change device configuration password

Before starting the configuration of the device you need to create your own configuration password or leave default value. To create your own configuration password is not necessary, but strongly recommended for security purposes. To create your own configuration password use the command shown below.

```
psw<old configuration password>EASY [space]passch<new configuration password>
```

Default configuration password is "0000". When creating a new configuration password use only (aA-zZ) and (0-9) symbols.

Example SMS Message	Response	Result
psw0000 EASY passch1111	Configuration changed	Password changed from 0000 to 1111.

Changing time zone

If the device has never had a fix before or the battery has been removed, the device date will be incorrect (2007/01/01). To synchronize device internal time device needs to receive at least one GPS signal from satellites. Place the device for a few minutes in the open sky and wait until GPS indicator LED will start flashing twice at a time. After time synchronization device time zone will be [GMT](#) (00:00). To set your local time zone send an SMS message:

```
psw<configuration password> EASY [space]gmt<+-number>
```

Example SMS Message	Response	Result
psw0000 EASY gmt+2	Configuration changed	Time changed from 10:23:22 to 12:23:22.

Change periodical data logging moving/on stop

By default device is logging its position in the memory while moving/on stop every 10 minutes (600 sec.). You can change this time by sending a simple SMS:

```
while moving: psw<configuration password> EASY [space]tsave<time (in sec.)>
```

```
on stop: psw<configuration password> EASY [space]tossave<time (in sec.)>
```

Example SMS Message	Response	Result
psw0000 EASY tsave3600	Configuration changed	Logging interval changed from 600sec.to 3600sec.

Example SMS Message	Response	Result
psw0000 EASY tossave3600	Configuration changed	Logging interval changed from 600sec.to 3600sec.

Change alarm settings

There are three alarm modes that can be set via easy SMS commands: m1 – SMS mode, m2 – Call mode and m3 – GPRS or SMS mode.



Note!

Alarm duration time will be set in seconds. Phone numbers can be set up to five. Alarm duration can't be less than 60 sec.

`psw<configuration password> EASY [space]alarm<method>t<alarm duration time><phone number>`

Example SMS Message	Response	Result
psw0000 EASY alarm m1 t3600 +37067000000	Configuration changed	Alarm method: SMS, duration time: 3600s,Alarm SMS destination number: +37067000000.

There are two ways to delete phone numbers from the alarm number list; one of them is to delete all phone numbers which are on the list. The first way is:

`psw<configuration password> EASY [space]alarm del`

Example SMS Message	Response	Result
psw0000 EASY alarm del	Configuration changed	Alarm number list is empty.

The second one is to delete phone numbers separately:

`psw<configuration password> EASY [space]alarm del <phone number>`

Example SMS Message	Response	Result
psw0000 EASY alarm del +37067000000	Configuration changed	+37067000000 removed from phone number list.

Change keyboard settings

Every key on the device keyboard has a number and can be configured to make a call to the determined phone number. By default key1, key2, key3 and key4 do not have any set functions. The key5 is already set to turn alarm on. To change keys configuration use a command shown below.

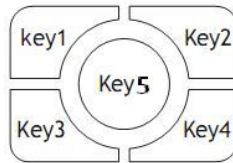

psw<configuration password> **EASY** [space]**key[x]** <phone number>

Example SMS Message	Response	Result
psw0000 EASY key1 +37067000000	Configuration changed	Function changed from none to +37067000000.

Change Man-down settings

To learn more about this function please read the chapter [Man-down function](#). To switch this function on/off a quick configuration SMS messages can be used. By default this function is off.

psw<configuration password> **EASY** [space]**mandown**<on/off>

Example SMS Message	Response	Result
psw0000 EASY mandown on	Configuration changed	Man-down function enabled.
psw0000 EASY mandown off	Configuration changed	Man-down function disabled.

Change parking settings

The minimum radius of parking zone is 200 meters. If you use configuration message without the radius, device will set the radius to its default one, or to the radius which was set in the last device configuration. To learn more about this feature please read the chapter Parking.

psw<password> **EASY** [space] **park onr**<radius>

Or you can also use

psw<password> **EASY** [space] **park on**

Example SMS Message	Response	Result
psw0000 EASY park on r280	Configuration changed	Parking function enabled, parking self geofence zone 280m.
psw0000 EASY park off	Configuration changed	Parking function disabled.

Change GPRS settings

Use the simple configuration SMS to configure all necessary parameters for GPRS connection to the server.

Information about your server IP address, SIM card connection authentication type, APN (Access point name), user name or password can be acquired from your local supplier of GSM services or device seller. The authentication type can be: 0-none, 1-pap, 2-chap.

psw<configuration password> **EASY** [space] **gprssp**<sending period in sec.>**ip**<IP>**p**<PORT>

apn<authentication type>,<Access Point Name>,username,password

Example SMS Message	Response	Result
psw0000 EASY gprs sp60 ip127.0.0.1 p8080 apn2,bigcompany.mnc012.mcc345.gprs,internet,mywap	Configuration changed	Every 60s device will connect to the server and send data stored on its memory. The server data settings: IP: 127.0.0.1, port 8080. GPRS connection settings: connection authentication type-PAP, access point name: bigcompany.mnc012.mcc345.gprs, user name: internet and password: mywap.

In case server does not require a password or a user name, you can send such SMS:

psw<configuration password> **EASY** [space]**gprssp**<send period in sec.>**ip**<IP>**p**<PORT>**apn**<authentication type>,<Access Point Name>

Example SMS Message	Response	Result
psw0000 EASY gprs sp60 ip127.0.0.1 p8080 apn2,bigcompany.mnc012.mcc345.gprs	Configuration changed	Every 60s device will connect to the server and send data stored on its memory. The server data settings: IP: 127.0.0.1 port 8080. GPRS connection settings: connection authentication type-PAP, access point name: bigcompany.mnc012.mcc345.gprs.



Note!

Please pay attention the parameters after the apn should be written without gap (space)

Battery charge level notification

If you would like to be informed about the battery charge level then the battery notification function has to be configured first. By default this function is on, but you need to set the message destination number. To change battery notification parameters by SMS send the command shown below:

psw<password> **EASY** [space]**battery num on**<phone number>

Example SMS Message	Response	Result
psw0000 EASY battery num on +37060011111	Configuration changed	Device will send SMS message when the battery charge level becomes less than the level is set.

Or you can also use:

psw<password> **EASY** [space]**battery num** <on/off>

Example SMS Message	Response	Result
psw0000 EASY battery num off	Configuration changed	Device will stop sending notification about battery charge level.

Restore settings to factory default

If your device does not work as you want or has been configured and you do not remember what you have done, do not worry, just restore device settings to factory defaults and try again. You can restore device settings by sending an SMS:

psw<password> **EASY** [space]**restore**

Example SMS Message	Response	Result
psw0000 EASY restore	Configuration changed	All parameters restored to factory defaults.

Advanced configuration

This type of configuration is for experienced users. Precise SMS message formats and rules how to correctly write them will be found in *GH4000 SMS Configuration Protocol* document. You can get this document from UAB Teltonika. Structure of the message is similar to one when configuration is made using terminal. You must follow these rules in order to change configuration:

1. Maximum length of the message – 160 characters;
2. Every command in the same line is separated by semicolon (;);
3. Command must be separated from parameter with colon (:);
4. Parameters must be separated with comma (,);
5. In order to delete commands parameters type (~) symbol;
6. Last command must be RST (RESET, device must to reset in order to work with new configuration);
7. It is not allowed to split command message in other two (first message has begging and other end).

Advanced configuration text message looks like this:

psw:<password>;CFG1;<command>:<parameter1>,<parameter2>,<parameter3>;RST

Example:

psw:0000;CFG1;GPS:1,130,300,1;RST

Device will respond with SMS message after successful change of configuration.

Configuration using terminal

Device configuration can be changed using Terminal (software which communicates with device through command line). Detailed description is described in *General Protocol Configuration* document. Terminal software can be downloaded from here: <http://avl1.teltonika.lt/downloads/GH4000/Software/Terminal>.

Main configuration steps:

- 1) Connect device to computer;
- 2) Choose COM port, to which device is connected to;
- 3) Press Open in order to connect device with computer;
- 4) Send command with device configuration password: #GH+PSW=0000;
- 5) Read device parameters: #GET:CFG1 ;
- 6) Send command with new parameters. Commands and parameters will be found in *General Protocol Configuration* document;
- 7) Save changed configuration: #SAVE:CFG1;
- 8) Reset GH4000: #RST. Device can be reset by pressing reset button too. Device has to be disconnected and connected again to computer via USB port in order to use terminal after reset.

Notice! Device will respond OK to correctly sent commands.

FAQ

Q: How to find out port number when using Windows XP operating system?

1. Right click on *My Computer*;
2. Select *Properties*;
3. Select *Hardware*;
4. Select *Device Manager*;
5. Locate GH4000 port name in *Ports* tab. Port number will be displayed in the brackets.

Q: How to take log file?

Download Terminal software from here: <http://avl1.teltonika.lt/downloads/GH4000/Software/Terminal> .

1. Plug GH4000 USB cable to computer and connect to Terminal;
2. Press *Log -> Start logging* and choose folder where to save file;
3. Enter these commands one by one:

```
#GH+psw=0000
```

#get:ver

#GET:IMEI

#STATUS

#GET:BAT

#DIR

crash_log_print

#get:cfg1

#debug=1

4. Wait for at least 30 minutes and after that enter this command:

#debug=0

5. Then stop logging file (*Log -> stop logging*);

6. Please, send that file to *Support* for further investigation of Your issue;

Q: Where to get newest GH4000 configurator Track Assistant and drivers?

GH4000 drivers are installed during Track Assistant's installation. Newest Track Assistant can be downloaded from here: <http://avl1.teltonika.lt/downloads/GH4000/Software/Track%20Assistant/Standard/>.

Q: How to create Geozone on GH4000 if there is no map?

1. To configure Geozone use manual Geozone creation method: circle or polygon;
2. You can install *Ms Map Point* from internet (it is paid);
3. Or you can use *Open Street* maps. Have installed newest base *Track Assistant* from here: <http://avl1.teltonika.lt/downloads/GH4000/Software/Track%20Assistant/Standard/>

Q: How much GH4000 device weight?

GH4000 - 72 g.

Q: How to configure GH4000 remotely?

GH4000 can be configured remotely only over SMS.

Q: How to get SMS with open street map link?

SMS format can be added or changed in Track Assistant>>Device Configuration>>GSM>>Edit SMS template window.
Open street map link: http://www.openstreetmap.org/?mlat=<fix_lat>&m lon=<fix_lon>#map=17/<fix_lat>/<fix_lon>

Q: To run Track Assistant on WIN7 64bit?

1. Uninstall an old Track Assistant if you have such one;
2. Disable User Account Control on WIN7;

3. Run such a command – ‘bcdedit /set loadoptions DDISABLE_INTEGRITY_CHECKS’ via "RUN";

4. Install new Track Assistant with GH4000 connected to computer.

Q: What to do when GH4000 cannot be found on computer?

1. Reconnect GH4000 USB cable;

2. Charge the battery to fully charged one;

3. Connected GH4000 to another USB port;

4. Try to connect GH4000 to another computer with a different OS system;

5. Try to change USB cable;

6. Check if GH4000 can be seen in 'Device Manager>>Ports' window. Make print screen of this window and send it to responsible person.

Q: How to turn off all possible sounds?

Use this SMS: PSW:0000;CFG1;NTFY:0,0,,1,1,1,1,1,1,1,1,1,1,1,1,,,,,1,1;RST

Q: How to read saved records in GH4000 memory?

Saved records can be read in Track Assistant>>Monitoring>>Device>>Periodical or alarm records window.